

38MBR Outdoor Unit Single Zone Ductless System Sizes 36 to 58

Service Manual

TABLE of CONTENTS

	PAGE
SAFETY CONSIDERATIONS	1
INTRODUCTION	1
MODEL / SERIAL NUMBER NOMENCLATURES	2
WIRING	3
CONNECTION DIAGRAM	3
WIRING DIAGRAMS	4
REFRIGERATION CYCLE DIAGRAM	8
REFRIGERANT LINES	9
SYSTEM EVACUATION AND CHARGING	10
SYSTEM VACUUM AND CHARGE	10
ELECTRONIC FUNCTIONS	11
POINT CHECK FUNCTION	14
TROUBLESHOOTING	16
DIAGNOSTIC GUIDES	17
DIAGNOSIS AND SOLUTION	18
DISASSEMBLY INSTRUCTIONS SIZE 36	47
DISASSEMBLY INSTRUCTIONS SIZE 48-58	53

SAFETY CONSIDERATIONS

Installing, starting up, and servicing air-conditioning equipment can be hazardous due to system pressures, electrical components, and equipment location (roofs, elevated structures, etc.).

Only trained, qualified installers and service mechanics should install, start-up, and service this equipment.

Untrained personnel can perform basic maintenance functions such as coil cleaning. All other operations should be performed by trained service personnel.

When working on the equipment, observe precautions in the literature and on tags, stickers, and labels attached to the equipment.

Follow all safety codes. Wear safety glasses and work gloves. Keep a quenching cloth and fire extinguisher nearby when brazing. Use care in handling, rigging, and setting bulky equipment.

Read this manual thoroughly and follow all warnings or cautions included in the literature and attached to the unit. Consult local building codes and National Electrical Code (NEC) for special requirements. Recognize safety information. This is the safety-alert symbol ⚠. When you see this symbol on the unit and in instructions or manuals, be alert to the potential for personal injury. Understand these signal words: **DANGER**, **WARNING**, and **CAUTION**.

These words are used with the safety-alert symbol. **DANGER** identifies the most serious hazards which **will** result in severe personal injury or death. **WARNING** signifies hazards which **could** result in personal injury or death. **CAUTION** is used to identify unsafe practices which **may** result in minor personal injury or product and property damage. **NOTE** is used to highlight suggestions which **will** result in enhanced installation, reliability, or operation.



WARNING

ELECTRICAL SHOCK HAZARD

Failure to follow this warning could result in personal injury or death. Before installing, modifying, or servicing system, main electrical disconnect switch must be in the OFF position. There may be more than 1 disconnect switch.

Lock out and tag switch with a suitable warning label.



WARNING

EXPLOSION HAZARD

Failure to follow this warning could result in death, serious personal injury, and/or property damage. Never use air or gases containing oxygen for leak testing or operating refrigerant compressors. Pressurized mixtures of air or gases containing oxygen can lead to an explosion.



CAUTION

EQUIPMENT DAMAGE HAZARD

Failure to follow this caution may result in equipment damage or improper operation.

Do not bury more than 36 in. (914 mm) of refrigerant pipe in the ground. If any section of pipe is buried, there must be a 6 in. (152 mm) vertical rise to the valve connections on the outdoor units. If more than the recommended length is buried, refrigerant may migrate to the cooler buried section during extended periods of system shutdown. This causes refrigerant slugging and could possibly damage the compressor at start-up.

INTRODUCTION

This service manual provides the necessary information to service, repair, and maintain the **38MBR** family of heat pumps. Use the "TABLE of CONTENTS" on page 1 to locate a desired topic. For detailed information regarding product specifications refer to product data documentation.

MODEL / SERIAL NUMBER NOMENCLATURES

Table 1 —Unit Sizes

SYSTEM TONS	kBTUh	VOLTAGE-PHASE	OUTDOOR MODEL
3.00	36,000	208/230-1	38MBRQ36A--3
4.00	48,000	208/230-1	38MBRQ48A--3
5.00	58,000	208/230-1	38MBRQ58A--3

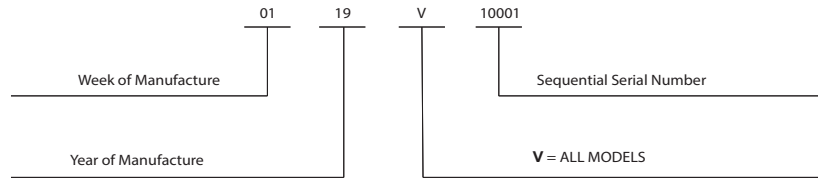
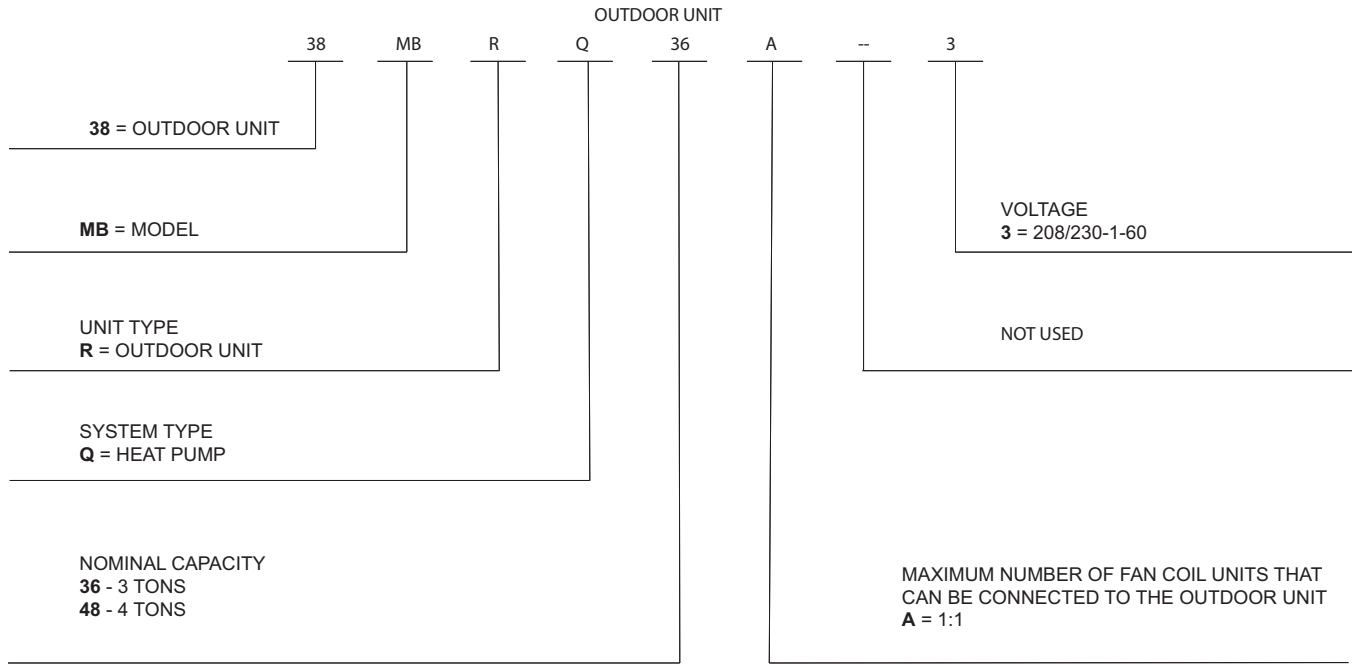

Use of the AHRI Certified TM Mark indicates a manufacturer's participation in the program. For verification of certification for individual products, go to www.ahrirectory.org.



WIRING

All wires must be sized per NEC (National Electrical Code) or CEC (Canadian Electrical Code) and local codes. Use Electrical Data table MCA (minimum circuit amps) and MOCP (maximum over current protection) to correctly size the wires and the disconnect fuse or breakers respectively.

Sizes 36-58 Recommended Connection Method for Power and Communication Wiring

Power and Communication Wiring:

The main power is supplied to the outdoor unit. The field supplied power wiring from the outdoor unit to the indoor unit consists of three (3) wires and provides the power for the indoor unit. Two wires are high voltage AC power and one is a ground wire. To minimize voltage drop, the factory recommended wire size is 14/2 stranded with a ground.

Communication Wiring:

A separate shielded stranded copper conductor only, with a 600 volt rating and double insulated copper wire, must be used as the communication wire from the outdoor unit to the indoor unit. Please use a separate shielded 16GA stranded control wire.

⚠ **CAUTION**

EQUIPMENT DAMAGE HAZARD
 Failure to follow this caution may result in equipment damage or improper operation.
 Wires should be sized based on NEC and local codes.

⚠ **CAUTION**

EQUIPMENT DAMAGE HAZARD
 Failure to follow this caution may result in equipment damage or improper operation.
 Be sure to comply with local codes while running wire from the indoor unit to the outdoor unit.
 Every wire must be connected firmly. Loose wiring may cause the terminal to overheat or result in unit malfunction. A fire hazard may also exist. Ensure all wiring is tightly connected.
 No wire should touch the refrigerant tubing, compressor or any moving parts.
 Disconnecting means must be provided and shall be located within sight and readily accessible from the air conditioner.
 Connecting cable with conduit shall be routed through the hole in the conduit panel.

CONNECTION DIAGRAM

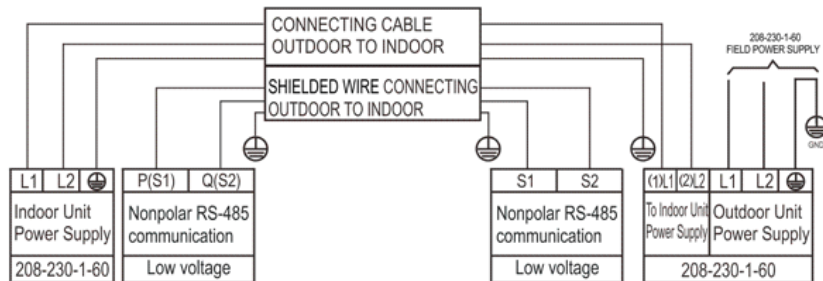

Fig. 1 — Connection Diagram

NOTES:

1. Do not use thermostat wire for any connection between indoor and outdoor units.
2. All connections between indoor and outdoor units must be as shown. The connections are sensitive to polarity and will generate a fault code.

WIRING DIAGRAMS

Size 36K

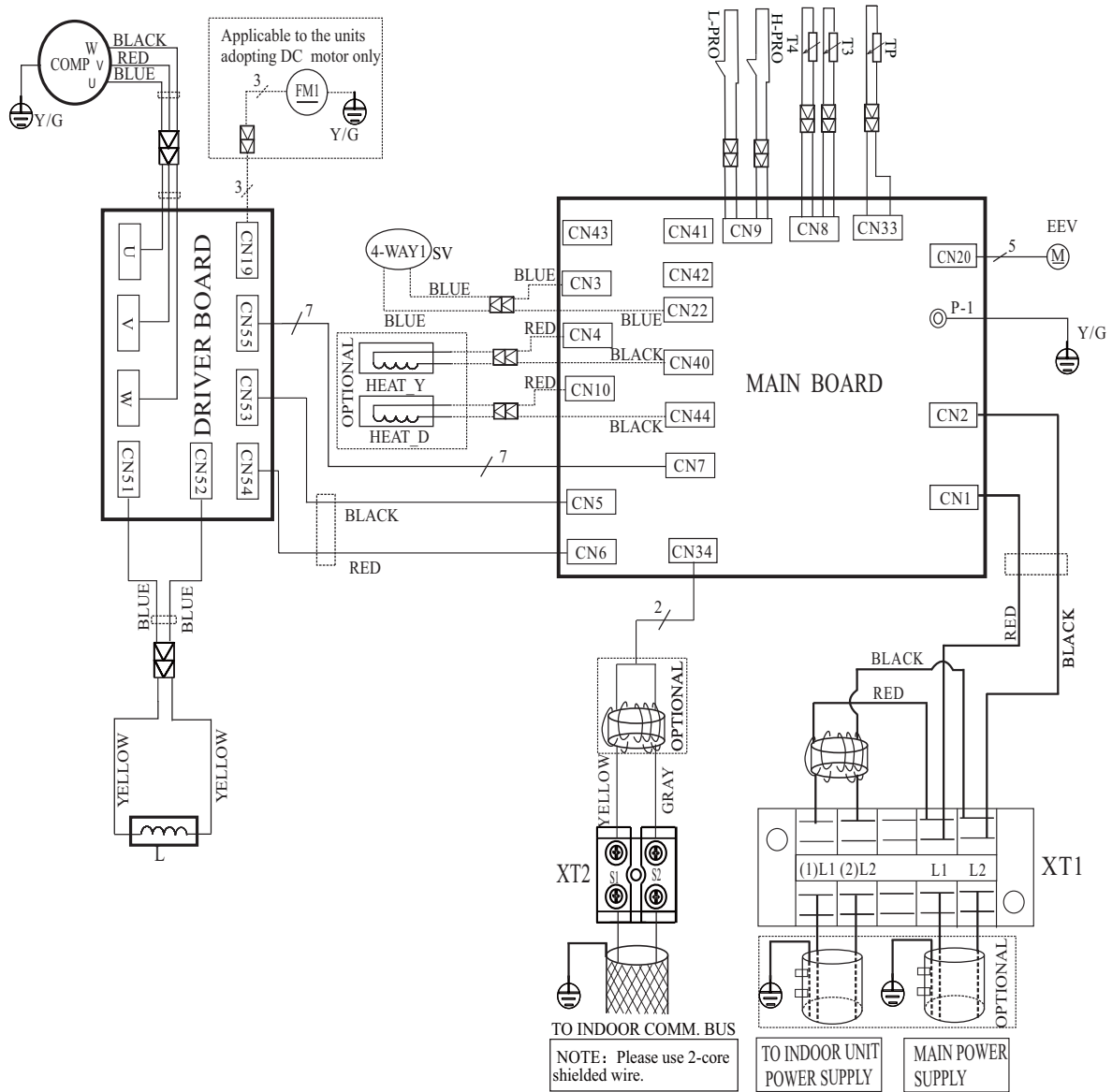

Fig. 2 — Wiring Diagram Size 36K

Table 2 — Wiring Diagram Size 36K Codes

CODE	PART NAME
CN1~CN2	Input: 230VAC High voltage
CN5~CN6	Output: 230VAC High voltage
P-1	Connection to the earth
CN10~CN44	Output: 230VAC High voltage Chassis Crankcase Heater
CN4~CN40	Output: 230VAC High voltage Compressor Crankcase Heat
CN3~CN22	Output: 230VAC High voltage
CN43	Output: Pin3~Pin2, Pin4~Pin2 (230 VAC High voltage) For AC FAN
CN41~CN42	Output To AC FAN Capacitor
CN34	Output:-24VDC-24VDC
CN33	Input: Pin 1 (0-5VDC),Pin 2 (5VDC) Discharge Temperature Sensor
CN8	Input: Pin3, Pin4 (5VDC),Pin2 (0VDC),Pin1,Pin5 (0-5VDC) T3 & T4
CN9	Input: Pin2, Pin4 (0VDC),Pin1,Pin3 (0-5VDC) H/L Pressure Switch
CN20	Output: Pin1~Pin4: Pulse waveform(0-12VDC),Pin5, Pin6 (12VDC)
CN7	Output: Pin1 (12VDC),Pin2 (5VDC),Pin3 (EARTH)

WIRING DIAGRAMS (CONT)**Size 36K****Table 3 — Wiring Diagram Size 36K Codes**

OUTDOOR UNIT PFC & IPM BOARD	
CODE	PART NAME
CN53~CN54	Input: 230VAC High voltage
CN55	Output: Pin1 (12VDC),Pin2 (5VDC),Pin3 (EARTH)
CN19	Pin1~Pin3: Connect to FAN voltage among phases 0~200VAC
U~V~W	Connect to compressor voltage among phases 0~200VAC
CN51~CN52	CN51~EARTH,CN52~EARTH Output: 224-380VDC High voltage

Table 4 — Wiring Diagram Sizes 09K, 12K, 18K (208-230V)

CODE	PART NAME	CODE	PART NAME
COMP	COMPRESSOR	L	PFC INDUCTOR
CAP1	FAN MOTOR CAPACITOR	L-PRO	LOW PRESSURE SWITCH
HEAT	CRANKCASE HEATING	H-PRO	HIGH PRESSURE SWITCH
FM1	OUTDOOR DC FAN	SV	4-WAY VALVE
FAN1	OUTDOOR AC FAN	T3	CONDENSER TEMPERATURE SENSOR
EEV	ELECTRONIC EXPANSION VALVE	T4	OUTDOOR AMBIENT TEMPERATURE SENSOR

WIRING DIAGRAMS (CONT)

Sizes 48K and 58K

Notes: -----

This symbol indicates the element is optional, the actual shape prevails.

WIRING DIAGRAM (OUTDOOR UNIT) 16022500003306

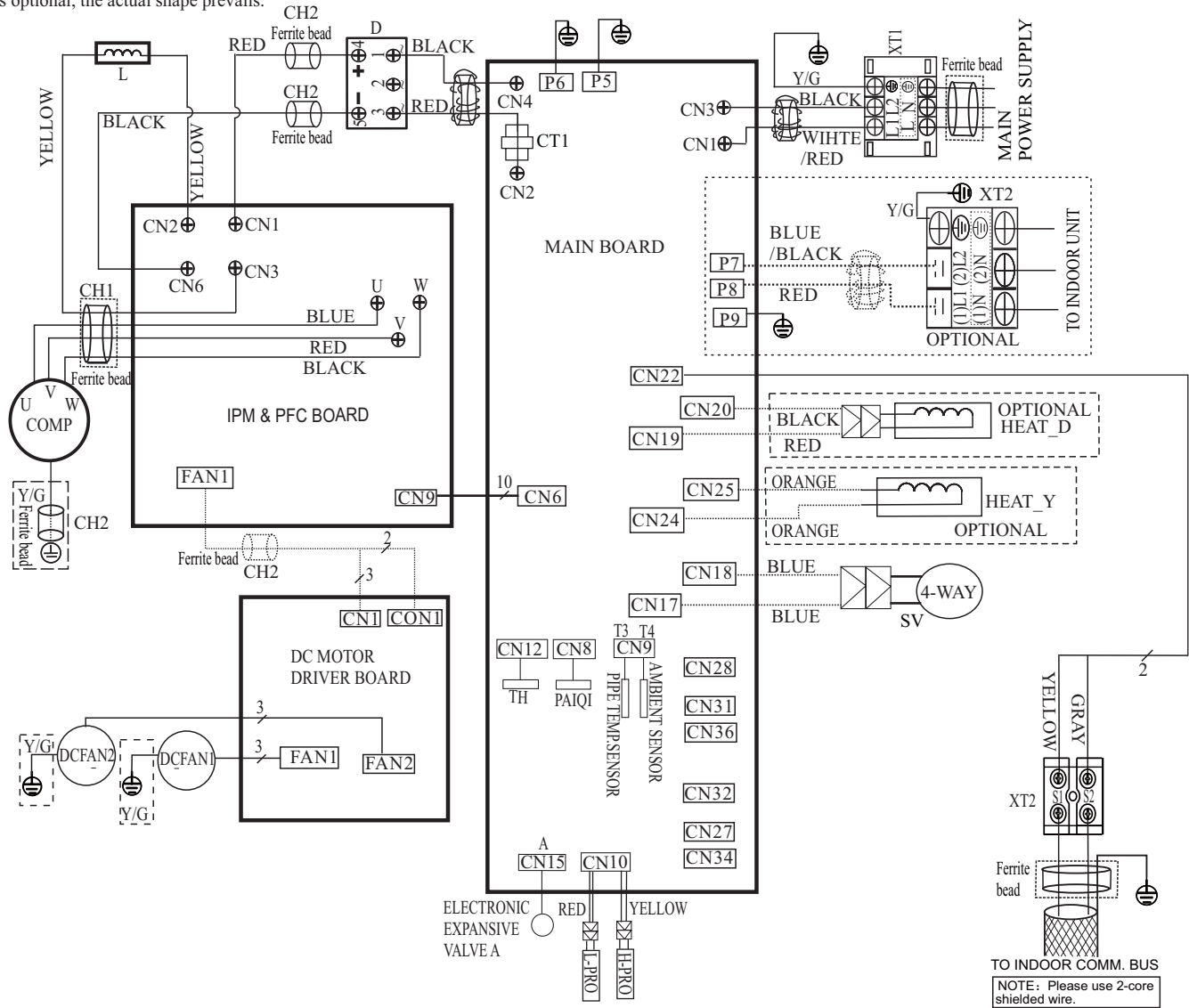

Fig. 3 — Wiring Diagram Sizes 48K and 58K

Table 5 — Wiring Diagram Sizes 48K and 58K Codes

CODE	PART NAME
CN1~CN3	Input: 230VAC High voltage
P7~P8	Output: 230VAC High voltage to IDU
P5,P6,P9	Connection to the earth
CN22	Output:-24VDC-24VDC for IDU Communication
CN17~CN18	Output: 230VAC High voltage 4 way valve
CN19~CN20	Output: 230VAC High voltage Chassis Crankcase Heater
CN24~CN25	Output: 230VAC High voltage Compressor Crankcase Heater
CN2~CN4	Output: 230VAC High voltage to AC CURRENT DETECTOR
CN12	Input: Pin1 (0-5VDC),Pin2 (5VDC) Heatsink Temperature Sensor
CN8	Input: Pin1 (0-5VDC),Pin2 (5VDC) Compressor Top Sensor (PAIQI)
CN9	Input: Pin3,Pin4 (5VDC),Pin2 (0VDC),Pin1,Pin5 (0-5VDC) the ambient sensor and pipe sensor
CN10	Input: Pin2, Pin4 (0VDC),Pin1,Pin3 (0-5VDC) for the H/L pressure switch
CN15	Output: Pin1-Pin4: Pulse waveform (0-12VDC),Pin5, Pin6 (12VDC) EEV
CN6	Output: Pin1-Pin6: Pulse waveform (0-5VDC), Pin7, Pin9 (0VDC) Pin8 (0-5VDC), Pin10 (5VDC)

Manufacturer reserves the right to change, at any time, specifications and designs without notice and without obligations.

WIRING DIAGRAMS (CONT)**Sizes 48K and 58K****Table 6 — Wiring Diagram Sizes 48K and 58K Codes**

OUTDOOR UNIT PFC & IPM BOARD	
CODE	PART NAME
CN1~CN6	Output:224-380VDC High voltage to DIODE MODULE
CN2~CN3	Output:224-380VDC High voltage to PFC INDUCTOR
U~V~W	Connection to compressor voltage among phases 0~200VAC
CN9	Input:Pin1-Pin6: Pulse waveform (0-5VDC),Pin7, Pin9 (0VDC) Pin8 (0-5VDC),Pin10 (5VDC)
FAN1	Output: Pin1~Pin2: High voltage (224-380VDC), Pin4 (0-15VDC) Pin5 (0-5.6VDC), Pin6:Pulse waveform (0-15VDC)

Table 7 — Wiring Diagram Sizes 48K and 58K Codes

OUTDOOR UNIT DC MOTOR DRIVER BOARD	
CODE	PART NAME
CON1	Output:Pin1~Pin2:High voltage (224-380VDC)
CN1	Input: Pin4: Pulse waveform (0-15VDC),Pin3 (0-6.5VDC) Pin2 (0VDC),Pin1 (15VDC)
FAN1	Pin1-Pin3: Connect to FAN voltage among phases 0~200VAC
FAN2	Pin1-Pin3: Connect to FAN voltage among phases 0~200VAC

Table 8 — Wiring Diagram Sizes 48K and 58K Codes

CODE	PART NAME
COMP	COMPRESSOR
CAP1,CAP2	FAN MOTOR CAPACITOR
CT1	AC CURRENT DETECTOR
D	DIODE MODULE
EEV	ELECTRONIC EXPANSION VALVE
FM1,FM2	OUTDOOR DC FAN
FAN1,FAN2	OUTDOOR AC FAN
HEAT	CRANKCASE HEATING
H-PRO	HIGH PRESSURE SWITCH
L	PFC INDUCTOR
L-PRO	LOW PRESSURE SWITCH
KM	AC CONTACTOR
SV	4-WAY VALVE
TP	EXHAUST TEMPERATURE SENSOR
T3	CONDENSER TEMPERATURE SENSOR
T4	OUTDOOR AMBIENT TEMPERATURE SENSOR
TH	HEATSINK TEMPERATURE SENSOR
PAIQI	COMPRESSOR TOP SENSOR (GAS PIPE SENSOR)
CH 1 CH 2 CH 3	FERRITE BEAD

REFRIGERATION CYCLE DIAGRAM

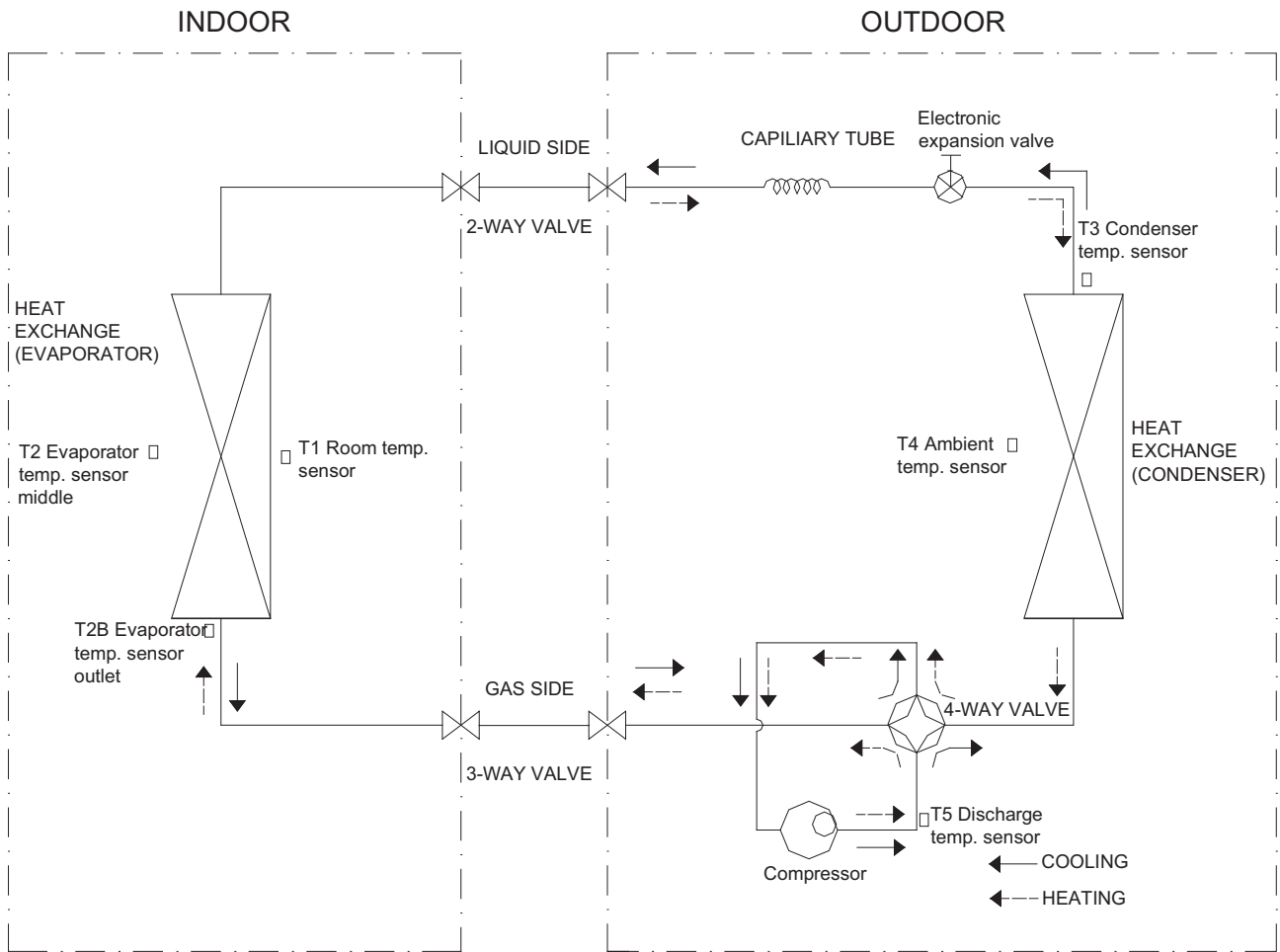

Fig. 4 — Refrigerant Cycle Diagram

REFRIGERANT LINES

General Refrigerant Line Sizing

1. The outdoor units are shipped with a full charge of R410A refrigerant. All charges, line sizing, and capacities are based on runs of 25ft. (7.6 m). For runs over 25 ft. (7.6 m), consult the long-line applications section for the proper charge adjustments.
2. The minimum refrigerant line length between the indoor and outdoor units is 10 ft. (3 m).
3. Refrigerant lines should not be buried in the ground. If it is necessary to bury the lines, not more than 36in (914 mm) should be buried. Provide a minimum 6in (152 mm) vertical rise to the service valves to prevent refrigerant migration.
4. Both lines must be insulated. Use a minimum of 1/2in. (12.7 mm) thick insulation. Closed-cell insulation is recommended in all long-line applications.
5. Special consideration should be given to isolating interconnecting tubing from the building structure. Isolate the tubing so vibration or noise is not transmitted into the structure.

IMPORTANT: Both refrigerant lines must be insulated separately.

Table 9 displays the following maximum lengths allowed.

Table 9 — Piping and Refrigerant

System Size			36K	48K	58K
PIPING	Min. Piping Length	ft (m)	10(3)	10(3)	10(3)
	Standard Piping Length	ft (m)	25(7.5)	25(7.5)	25(7.5)
	Max. outdoor-indoor height difference (OU higher than IU)	ft (m)	98(30)	98(30)	98(30)
	Max. outdoor-indoor height difference (IU higher than OU)	ft (m)	98(30)	98(30)	98(30)
	Max. Piping length with no additional refrigerant charge	ft (m)	26(8)	26(8)	26(8)
	Max. Piping Length	ft (m)	213(65)	213(65)	213(65)
	Additional refrigerant charge (between Standard - Line Lengths Max piping length)	Oz/ft (g/m)	0.32 (30)	0.32 (30)	0.32(30)
	Gas Pipe (size-connection type)	in (mm)	5/8(16)	5/8(16)	3/4(19)
Liquid Pipe (size-connection type)	in (mm)	3/8(9.52)	3/8(9.52)	3/8(9.52)	
REFRIGERANT	Refrigerant Type	--	R410A	R410A	R410A
	Charge Amount	Lbs (kg)	6.72(3.05)	9.26(4.2)	10.19(4.62)

- The charge amount listed in Table 9 is for piping runs up to 25 ft. (7.6 m).
- For piping runs greater than 25 ft. (7.6 m), add refrigerant up to the allowable length as specified in Table 10.

Long Line Applications.:

1. No change in line sizing is required.
2. Add refrigerant per Table 10.

Table 10 — Additional Charge Table Per Zone

UNIT SIZE	TOTAL LINE LENGTH FT.		ADDITIONAL CHARGE OZ/FT. (M)	
	MIN.	MAX.	>10-25 (3-8)	>25-213 (8-65)
36	10	213	None	0.32
48				
58				

SYSTEM EVACUATION AND CHARGING

CAUTION

UNIT DAMAGE HAZARD
 Failure to follow this caution may result in equipment damage or improper operation.

Never use the system compressor as a vacuum pump.

Refrigerant tubes and indoor coil should be evacuated using the recommended deep vacuum method of 500 microns. The alternate triple evacuation method may be used if the following procedure is followed. Always break a vacuum with dry nitrogen.

SYSTEM VACUUM AND CHARGE

Using Vacuum Pump

1. Completely tighten the flare nuts (A, B, C, D, E). Fully open all circuits service valves. Connect the manifold gage charge hose to the charge port of the low side Master service valve to evacuate all circuits at the same time (see Fig. 5).
2. Connect charge hose to vacuum pump.
3. Fully open the low side of manifold gage (see Fig. 6).
4. Start vacuum pump
5. Evacuate using the triple evacuation method.
6. After evacuation is complete, fully close the low side of manifold gage and stop operation of vacuum pump.
7. The factory charge contained in the outdoor unit is good for up to 25ft. (8 m) of line length. For refrigerant lines longer than 25ft. (8 m), add refrigerant as specified in "Additional Charge Table Per Zone" on page 9.
8. Disconnect charge hose from charge connection of the low side service valve.
9. Securely tighten caps of service valves.

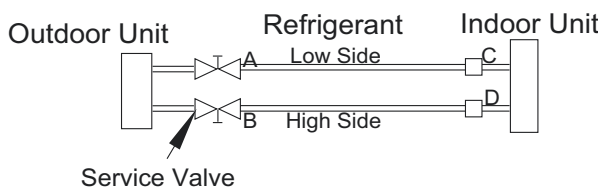

Fig. 5 — Service Valve

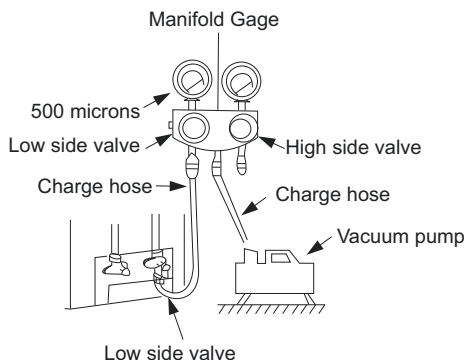

Fig. 6 — Manifold

Deep Vacuum Method

The deep vacuum method requires a vacuum pump capable of pulling a vacuum of 500 microns and a vacuum gage capable of accurately measuring this vacuum depth. The deep vacuum method is the most positive way of assuring a system is free of air and liquid water (see Fig. 7).

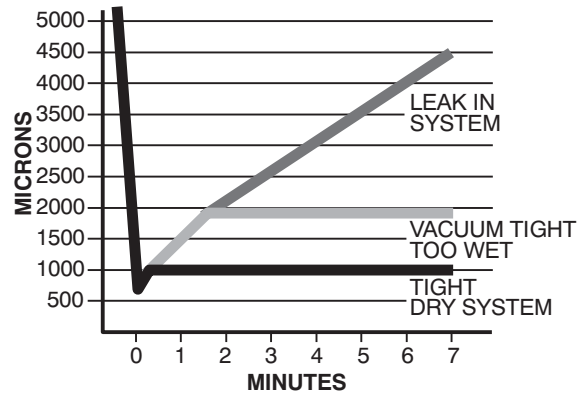

Fig. 7 — Deep Vacuum Graph

Triple Evacuation Method

The triple evacuation method should be used. Refer to Fig. 8 and proceed as follows:

1. Pump system down to 500 MICRONS of mercury and allow pump to continue operating for an additional 15 minutes. Unit must maintain 500 microns or less for 30 minutes or more to ensure a dry system.
2. Close service valves and shut off vacuum pump.
3. Connect a nitrogen cylinder and regulator to system and open until system pressure is 2 psig.
4. Close service valve and allow system to stand for 10 minutes. During this time, dry nitrogen will be able to diffuse throughout the system absorbing moisture.
5. Repeat this procedure as indicated in Fig. 8. System will then be free of any contaminants and water vapor.

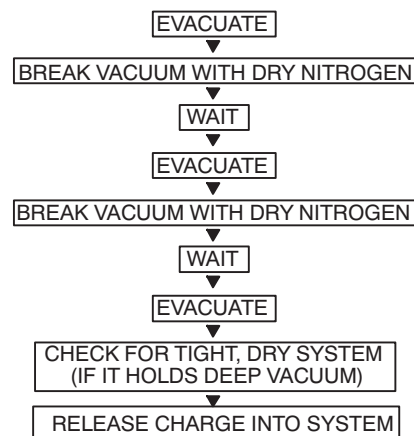

Fig. 8 — Triple Evacuation Method

Final Tubing Check

IMPORTANT: Check to be certain factory tubing on both indoor and outdoor unit has not shifted during shipment. Ensure tubes are not rubbing against each other or any sheet metal. Pay close attention to feeder tubes, making sure wire ties on feeder tubes are secure and tight.

ELECTRONIC FUNCTIONS

Abbreviation

- T1: Indoor room temperature
- T2: Coil temperature of indoor heat exchanger middle
- T2B: Coil temperature of indoor heat exchanger outlet
- T3: Coil temperature of condenser
- T4: Outdoor ambient temperature
- T5: Compressor discharge temperature
- Td: Target temperature

Main Protection

Three Minute Delay for Compressor Restart

Less than a 1 minute delay for the initial start-up and a 3 minute delay for subsequent starts.

Compressor Top Temperature Protection

The unit stops working when the compressor top temp. protector cuts off, and restarts after the compressor top temp. protector restarts.

Compressor Discharge Temperature Protection

When the compressor discharge temp. increases, the running frequency is limited per the following rules:

- Compressor discharge temp. $T5 > 239^\circ\text{F} (115^\circ\text{C})$ for 5s, compressor stops and restarts up until $T5 < 194^\circ\text{F} (90^\circ\text{C})$
- $110 < T5 < 239^\circ\text{F} (115^\circ\text{C})$, decrease the frequency to the lower level every 2 minutes.
- $221^\circ\text{F} (105^\circ\text{C}) < T5 < 230^\circ\text{F} (110^\circ\text{C})$, keep running at the current frequency.
- $T5 < 221^\circ\text{F} (105^\circ\text{C})$, no limit for frequency.

Fan Speed is Out of Control

When the indoor fan speed remains low (lower than 300RPM) for 50s, the indoor fan shuts off and restarts 30s later. If the protection mode engages 3 times when the fan motor restarts continuously, the unit stops and the LED displays the failure.

When the outdoor fan speed remains low (lower than 100RPM) or too high (higher than 1500RPM) for 60s, the unit stops and the LED displays the failure. The malfunction clears 30s later.

Inverter Module Protection

The inverter module has a protection function for current, voltage and temperature. If any of these protections engage, the corresponding code displays on the indoor unit and the unit stops working.

Indoor Fan Delayed Open Function

When the unit starts up, the louver is active immediately and the indoor fan opens 10s later. If the unit is running in the **HEATING** mode, the indoor fan is controlled also by the anti-cold wind function.

Compressor Preheating Functions

Preheating Permitting Condition:

If $T4 < 37.4^\circ\text{F} (3^\circ\text{C})$ and the machine connects to power supply newly within 5 seconds or if $T4 < 37.4^\circ\text{F} (3^\circ\text{C})$ and the compressor has stopped for over 3 hours, the compressor heating cable will work.

Preheating Mode:

A weak current flow through the compressor coil from the compressor wiring terminal, then the compressor is heated without operation.

Preheating Release Condition:

If $T4 = 41^\circ\text{F} (5^\circ\text{C})$ or the compressor starts running, the preheating function stops.

Condenser High Temperature T3 Protection:

- $131^\circ\text{F} (55^\circ\text{C}) < T3 < 140^\circ\text{F} (60^\circ\text{C})$, the compressor frequency decreases to the lower level until to F1 and then runs at F1. If $T3 < 129.2^\circ\text{F} (54^\circ\text{C})$, the compressor keeps running at the current frequency.
- $T3 < 125.6^\circ\text{F} (52^\circ\text{C})$, the compressor does not limit the frequency and resumes the former frequency.
- $T3 > 140^\circ\text{F} (60^\circ\text{C})$ for 5 seconds, the compressor stops until $T3 < 125.6^\circ\text{F} (52^\circ\text{C})$.

Evaporator Low Temperature T2 Protection:

- $T2 < 32^\circ\text{F} (0^\circ\text{C})$, the compressor stops and restarts when $T2 = 41^\circ\text{F} (5^\circ\text{C})$.
- $32^\circ\text{F} (0^\circ\text{C}) \leq T2 < 39.2^\circ\text{F} (4^\circ\text{C})$, the compressor frequency is limited and decreases to the lower level
- $39.2^\circ\text{F} (4^\circ\text{C}) = T2 < 44.6^\circ\text{F} (7^\circ\text{C})$, the compressor retains the current frequency
- $T2 > 44.6^\circ\text{F} (7^\circ\text{C})$, the compressor frequency is not limited.

Operation Modes and Functions

FAN Mode

1. Outdoor fan and compressor stop
2. Temperature setting function is disabled and no setting temperature appears.
3. Indoor fan can be set to high/med/low/auto
4. The louver operates same as in the **COOLING** mode.
5. Auto fan

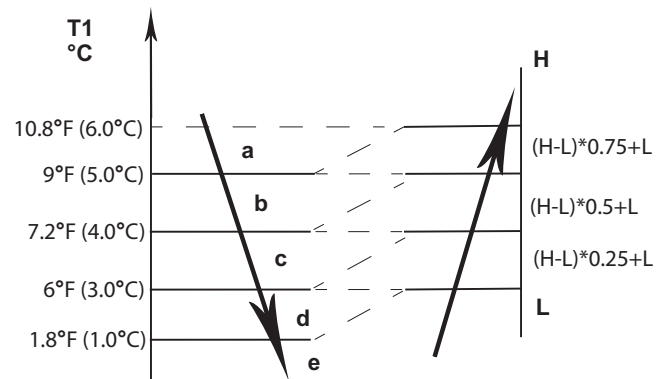

Fig. 9 — FAN Mode

COOLING Mode

Outdoor Fan Running Rules

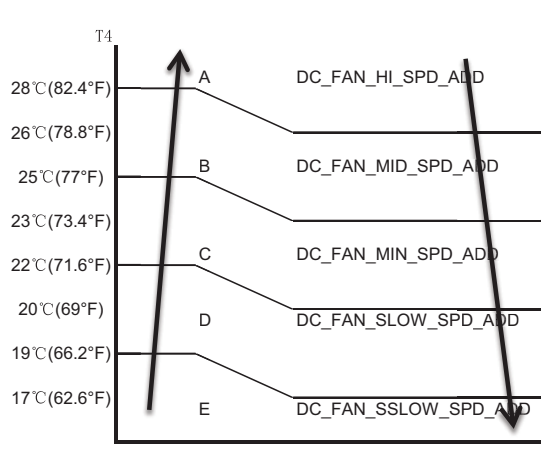

Fig. 10 — Outdoor Fan Running Rules

In the **COOLING** mode, the indoor fan runs all the time and the speed can be selected as high, medium, low and auto. The indoor fan is controlled as shown in Fig. 11.

Setting Fan Speed	T1-Td °F (°C)	Actual Fan Speed
H	4.5(40.1)	H+(H+=H+G)
	3.0(37.4)	H (=H)
	1.5(34.7)	H- (H=H-G)
M	4.5(40.1)	M+(M+=M+Z)
	3.0(37.4)	M(M=M)
	1.5(34.7)	M-(M-=M-Z)
L	4.5(40.1)	L+(L+=L+D)
	3.0(37.4)	L(L=L)
	1.5(34.7)	L-(L-=L-D)

Fig. 11 — Indoor Fan Table

The **AUTO** Fan function under the **COOLING** mode acts (see Fig. 12).

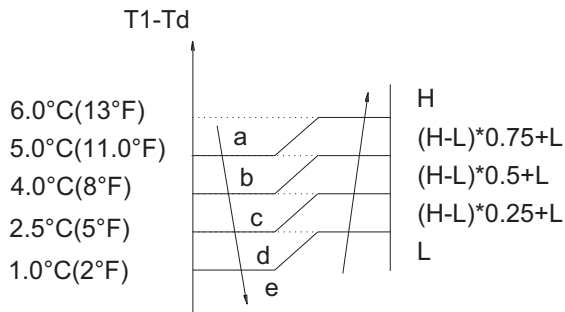

Fig. 12 —AUTO Fan function under the COOLING Mode

HEATING Mode

Outdoor Fan Running Rules

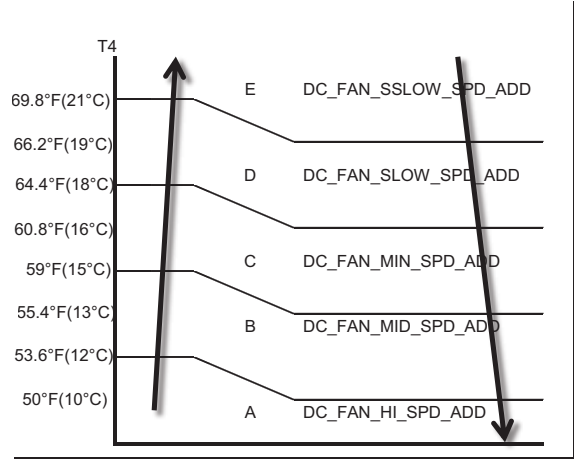

Fig. 13 — Outdoor Fan Running Rules

Indoor Fan Running Rules

When the compressor is on, the indoor fan can be set to high/med/low/ auto. And the anti-cold wind function has the priority. The indoor fan is controlled as shown in Fig. 14.

Setting Fan Speed	T1-Td+34.7°F(1.5°C)	Actual Fan Speed
H	-3°F(-1.5°C)	H- (H=H-G)
	-6°F(-3.0°C)	H (=H)
	-10°F(-4.5°C)	H+(H+=H+G)
M	-3°F(-1.5°C)	M-(M-=M-Z)
	-6°F(-3.0°C)	M(M=M)
	-10°F(-4.5°C)	M+(M+=M+Z)
L	-3°F(-1.5°C)	L-(L-=L-D)
	-6°F(-3.0°C)	L(L=L)
	-10°F(-4.5°C)	L+(L+=L+D)

Fig. 14 — Indoor Fan Running Rules

AUTO Fan action in HEATING mode

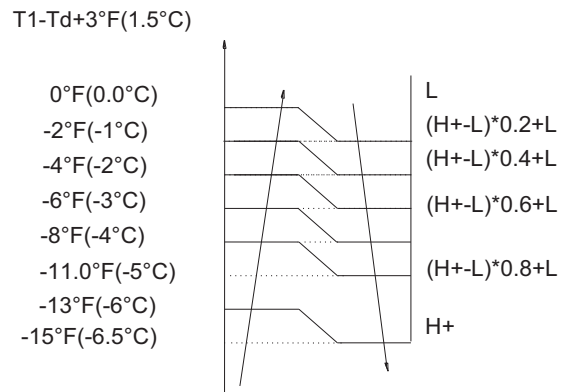
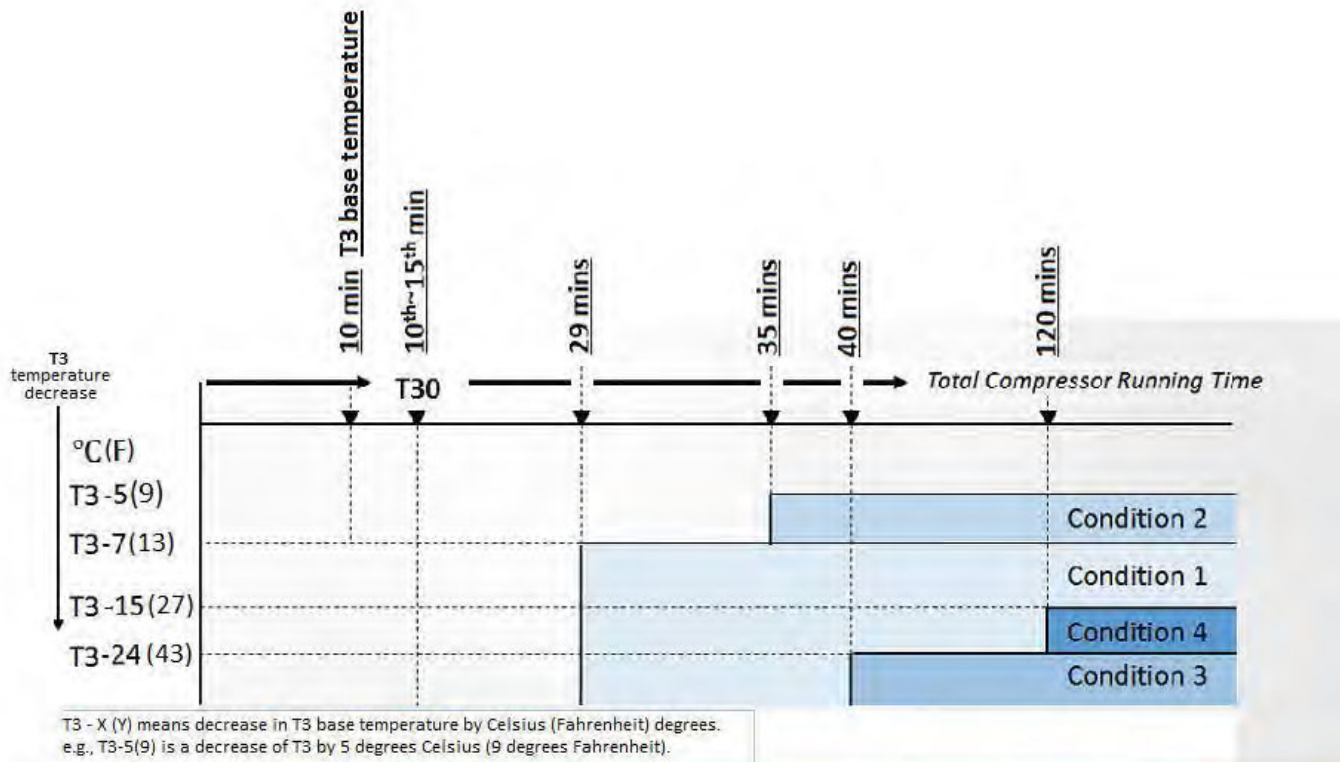

Fig. 15 — AUTO Fan action in HEATING mode

Defrosting Mode

If any one of the following conditions are met, AC enters the **DEFROSTING** mode. After the compressor starts and continues to run, mark the minimum value of T3 from the 10th minute to 15th minute as T30.



	Compressor run time	Temperature Change
Condition 1	Total compressor running time is 29 mins	T3-7°C & T30-2.5°C
Condition 2	Total compressor running time is 35 mins	T3-5 & T30-3°C
Condition 3	Total compressor running time is 40 mins	T3 -24°C for 3 mins
Condition 4	Total compressor running time is 120 mins	T3 -15°C

Defrost Exit Conditions: Any of the following conditions will terminate Defrost and return the unit to normal heating mode.

Note: T3 temperature refers to the sensor reading at the time when Defrost begins.

T3 temperature rises above 15°C (59°F).

T3 temperature remains above 8°C (46°F) for more than 80 seconds.

The unit has been in Defrost Mode for 10 minutes.

Fig. 16 — Defrosting Chart

Evaporator Coil Temperature Protection

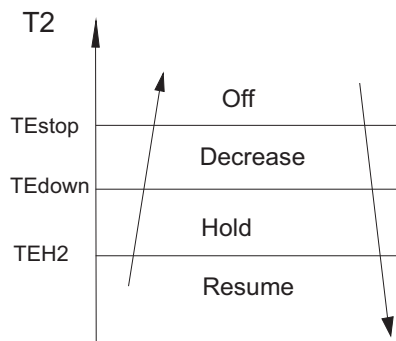

Fig. 17 — Evaporator Coil Temperature Protection

Off: Compressor stops

Decrease: Decrease the running frequency to the lower level

Hold: Keep the current frequency

Resume: No limitation for frequency

Auto Mode

This mode can be chosen with remote controller and the setting temperature can be changed between 62.6~86°F(17~30°C).

In **AUTO** mode, the machine either selects **COOLING**, **HEATING** or **FAN-Only** mode according to ΔT ($\Delta T=T1-Ts$).

$\Delta T=T1-Ts$	Running Mode
$\Delta T \geq 2F(1\text{ }^{\circ}\text{C})$	Cooling Mode
$-2^{\circ}\text{F}(-1\text{ }^{\circ}\text{C}) < \Delta T < 3(2^{\circ}\text{F}1\text{ }^{\circ}\text{C})$	Fan-only Mode
$\Delta T \leq -1\text{ }^{\circ}\text{C} (-2^{\circ}\text{F})$	Heating Mode

The indoor fan runs in the **AUTO** Fan mode of the relevant mode.

The louver operates same as in relevant mode. If the machine switches mode between heating and cooling, the compressor will continue to stop for 15 minutes and then choose a mode according to $T1-Ts$. If the setting temperature is modified, the machine selects a running function once again.

DRYING Mode

DRYING mode works the same as **COOLING** mode in **BREEZE** speed. All protections are active and the same as that in the **COOLING** mode.

Auto-Restart Function

The indoor unit is equipped with an auto-restart function, which is carried out through an auto-restart module. In case of a sudden power failure, the module memorizes the setting conditions before the power failure. The unit resumes the previous operation setting (not including sleep function) automatically after 3 minutes when power returns.

POINT CHECK FUNCTION

Press the remote controller **LED DISPLAY** or **LED** or **MUTE** three times, and then press **AIR DIRECTION** or **SWING** three times in ten seconds (the buzzer rings for two seconds). The air conditioner enters the information enquiry status.

The user can press the **LED DISPLAY** or **AIR DIRECTION** to check the next or front item's information. When the air conditioner enters the enquiry information status, it displays the code name in 2 seconds. Refer to Table 11 for details.

Table 11 — Enquiry Information

ENQUIRY INFORMATION	DISPLAYING CODE	MEANING
T1	T1	T1 temp.
T2	T2	T2 temp.
T3	T3	T3 temp.
T4	T4	T4 temp.
T2B	Tb	T2B temp.
TP	TP	TP (T5) temp.
TH	TH	TH temp.
Targeted Frequency	FT	Targeted Frequency
Actual Frequency	Fr	Actual Frequency
Indoor Fan Speed	IF	Indoor Fan Speed
Outdoor Fan Speed	OF	Outdoor Fan Speed
EXV Opening Angle	LA	EXV Opening Angle
Compressor Continuous Running Time	CT	Compressor Continuous Running Time
Compressor Stop Issues	ST	Compressor Stop Issues

When the air conditioner enters the information enquiry status, the **LED** displays the code value within 25 seconds (see Table 12 on page 15).

Enquiry Information

Table 12 — Enquiry Information

ENQUIRY INFORMATION	DISPLAY VALUE	MEANING	REMARK
T1,T2,T3,T4, T2B,TP,TH, Targeted Frequency, Actual Frequency	- 1F,- 1E,- 1d,- 1c,- 1 b,- 1A	- 25,- 24,- 23,- 22,- 21,- 20	1. All the displaying temperature is actual value. 2. Temperature is °C no matter the remote. 3. T1, T2, T3, T4, T2B display range:- 25~ 70, 4. TP display range:- 20~ 130. 5. Frequency display range: 0~159HZ. 6. If the range, it displays the maximum value or minimum value.
	- 19—99	- 19—99	
	A0,A1,●●●A9	100,101,●●●109	
	b0,b1,●●●b9	110,111,●●●119	
	c0,c1,●●●c9	120,121,●●●129	
	d0,d1,●●●d9	130,131,●●●139	
	E0,E1,●●●E9	140,141,●●●149	
	F0,F1,●●●F9	150,151,●●●159	
Indoor fan speed/ Outdoor fan speed	0	OFF	
	1,2,3,4	Low speed, Medium speed, High speed, Turbo	For some big capacity motors
	14- FF	Actual fan speed = Display value turns to decimal value and then multiply 10. The unit is RPM.	For some small capacity motors the display value is 14- FF (hexadecimal), the corresponding fan speed range is from 200- 2550 RPM.
EXV opening angle	0- FF	Actual EXV opening value = Display value turns to decimal value and then multiply 2.	
Compressor continuous running time	0- FF	0- 255 minutes	If the actual value exceeds the range, it displays the maximum value or minimum value.
Compressor stop causes	0- 99	For a detailed meaning, please consult with an engineer	Decimal display
Reserve	0- FF		

TROUBLESHOOTING

This section provides the required flow charts to troubleshoot problems that may arise.

NOTE: Information required in the diagnoses can be found in the wiring diagrams.

Required Tools:

The following tools are needed when diagnosing the units:

- Digital multimeter
- Screw drivers (Phillips and straight head)
- Needle-nose pliers
- Refrigeration gauges

Recommended Steps

1. Refer to the diagnostic hierarchy charts below and determine the problem at hand.
2. Go to the chart listed in the diagnostic hierarchy and follow the steps in the chart for the selected problem.

For the ease of service, the systems are equipped with diagnostic code display LED's on both the indoor and outdoor units. The outdoor diagnostic display is on the outdoor unit board and is limited to very few errors. The indoor diagnostic display is a combination of flashing LED's on the display panel on the front of the unit. If possible always check the diagnostic codes displayed on the indoor unit first.

The diagnostic codes for the indoor and outdoor units are listed in the following pages.

Problems may occur that are not covered by a diagnostic code, but are covered by the diagnostic flow charts. These problems are typical air conditioning mechanical or electrical issues that can be corrected using standard air conditioning repair techniques.

For problems requiring measurements at the control boards, note the following:

1. Always disconnect the main power.
2. When possible check the outdoor board first.
3. Start by removing the outdoor unit top cover.
4. Reconnect the main power
5. Probe the outdoor board inputs and outputs with a digital multi-meter referring to the wiring diagrams.
6. Connect the red probe to hot signal and the black probe to the ground or negative.
7. Note that some of the DC voltage signals are pulsating voltages for signal. this pulse should be rapidly moving at all times when there is a signal present.
8. If it is necessary to check the indoor unit board you must start by disconnecting the main power.
9. Next remove the front cover of the unit and then control box cover.
10. Carefully remove the indoor board from the control box, place it face up on a plastic surface (not metal).
11. Reconnect the main power and repeat steps 5, 6, and 7.
12. Disconnect main power before reinstalling board to avoid shock hazard and board damage.

DIAGNOSTIC GUIDES

Table 13 — Indoor Unit Error Display

OPERATION LAMP	TIMER LAMP	DISPLAY	LED STATUS	SOLUTION
☆ 1 time	X	E0	Indoor unit EEPROM parameter error	Page 20
☆ 2 times	X	E1	Communication malfunction between indoor and outdoor units	Page 22
☆ 4 times	X	E3	Fan speed is operating outside of the Normal Range	Page 25
☆ 5 times	X	E4	Indoor room temperature sensor (T1) malfunction	Page 26
☆ 6 times	X	E5	Evaporator coil temperature sensor (T2) malfunction	Page 26
☆ 7 times	X	EC	Refrigerant leakage detection	Page 27
☆ 8 times	X	EE	Water-level alarm malfunction	Refer to Indoor Unit Service Manual
☆ 1 time	O	F0	Current overload protection	Page 21
☆ 2 times	O	F1	Outdoor ambient temperature sensor (T4) malfunction	Page 26
☆ 3 times	O	F2	Condenser coil temperature sensor (T3) malfunction	Page 26
☆ 4 times	O	F3	Compressor discharge temperature sensor (T5) malfunction	Page 26
☆ 5 times	O	F4	Outdoor unit EEPROM parameter error	Page 20
☆ 6 times	O	F5	Outdoor fan speed malfunction	Page 25
☆ 7 times	O	F6	Indoor coil outlet pipe sensor (Located on outdoor unit low pressure valve)	Refer to Indoor Unit Service Manual
☆ 8 times	O	F7	Communication malfunction between the cassette optional lift panel and the unit	Refer to Indoor Unit Service Manual
☆ 9 times	O	F8	Cassette optional lift panel malfunction	Refer to Indoor Unit Service Manual
☆ 10 times	O	F9	Cassette optional lift panel not closed	Refer to Indoor Unit Service Manual
☆ 1 time	☆	P0	Inverter module (IPM) malfunction	Page 28
☆ 2 times	☆	P1	Over-voltage or under-voltage protection	Page 31
☆ 3 times	☆	P2	Compressor top high temperature protection (OLP)	Page 32
☆ 4 times	☆	P3	Low ambient temperature cut off in HEATING mode	Refer to Indoor Unit Service Manual
☆ 5 times	☆	P4	Compressor drive malfunction	Page 33
☆ 6 times	☆	P5	Indoor units mode conflict	Refer to Indoor Unit Service Manual
☆ 7 times	☆	P6	Low pressure protection	Refer to Indoor Unit Service Manual
☆ 8 times	☆	P7	Outdoor IPM temperature sensor error	Page 34

O (light) X (off) ☆ (flash)

Table 14 — Error Display on Two Way Communication Wired Controller

DISPLAY	LED STATUS	SOLUTION
F0	Communication error between wired controller and indoor unit	Page 21
F1	The cassette faceplate is abnormal	Page 26
E1	Communication malfunction between indoor and outdoor units	Page 22
E2	Indoor room temperature sensor (T1) malfunction	Refer to Indoor Unit Service Manual
E3	Evaporator coil temperature sensor (T2) malfunction	Refer to Indoor Unit Service Manual
E5	Outdoor ambient temperature sensor (T4) malfunction	Page 26
E5	Condenser coil temperature sensor (T3) malfunction	Page 26
E5	Compressor discharge temperature sensor (T5) malfunction	Page 26
E7	Indoor unit EEPROM parameter error	Refer to Indoor Unit Service Manual
E8	Indoor fan speed malfunction	Refer to Indoor Unit Service Manual
EF	Refrigerant leak detection	Refer to Indoor Unit Service Manual
EE	Water-level alarm malfunction	Refer to Indoor Unit Service Manual
ED	Outdoor unit EEPROM parameter error	Refer to Indoor Unit Service Manual
ED	Outdoor fan speed malfunction	Refer to Indoor Unit Service Manual
EB	Inverter module (IPM) malfunction	Refer to Indoor Unit Service Manual
EF	Other malfunction	

DIAGNOSIS AND SOLUTION

Outdoor Unit Error Display

Table 15 — Diagnostic Guide for Outdoor Units

NO.	PROBLEMS	ERROR CODE	SOLUTION
1	Communication malfunction between indoor and outdoor units	E1	Page 22
2	Current overload protection	F0	Page 21
3	Outdoor ambient temperature sensor (T4) malfunction	F1	Page 26
4	Condenser coil temperature sensor (T3) malfunction	F2	Page 26
5	Compressor discharge temperature sensor (T5) malfunction	F3	Page 26
6	Outdoor unit EEPROM parameter error	F4	Page 20
7	Outdoor fan speed malfunction	F5	Page 25
8	Inverter module (IPM) malfunction	P0	Page 27
9	Over-voltage or under-voltage protection	P1	Page 31
10	Compressor top high temperature protection (OLP)	P2	Page 32
11	Low ambient temperature cut off in HEATING mode	P3	Refer to Indoor Unit Service Manual
12	Compressor drive malfunction	P4	Page 33
13	High temperature protection of indoor coil in HEATING mode	J0	Page 35
14	Outdoor temperature protection of outdoor coil in COOLING	J1	Page 36
15	Temperature protection of compressor discharge	J2	Page 37
16	PFC module protection	J3	Page 38
17	Communication malfunction between control board and IPM board	J4	Page 39
18	High pressure protection	J5	Page 40
19	Low pressure protection	J6	Page 41
20	Outdoor IPM module temperature sensor malfunction	P7	Page 34
21	AC voltage protection	J8	Page 42

Table 16 — Outdoor Check Function

N	DISPLAY	REMARK		
00	Normal display	Display running frequency, running state or malfunction code		
01	Indoor unit capacity demand code	Actual data*HP*10 If the capacity demand code is higher than 99, the digital display tube displays a single digit and a ten digit. (For example, the digital display tube displays "5.0" it means the capacity demand is 15. The digital display tube displays "60" it means the capacity demand is 6.0).		
02	Amendatory capacity demand code			
03	The frequency after the capacity requirement transfer			
04	The frequency after the frequency limit			
05	The frequency of sending to 341 chip			
06	Indoor unit evaporator outlet temp. (HEATING T2, COOLING T2B)	If the temp. is lower than 0 degree, the digital display tube displays "0". If the temp. is higher than 70 degree, the digital display tube displays "70".		
07	Condenser pipe temp.(T3)	If the temp. is lower than -9 degree, the digital display tube displays "-9". If the temp. is higher than 70 degree, the digital display tube displays "70". If the indoor unit is not connected, the digital display tube displays: "--"		
08	Outdoor ambient temp.(T4)			
09	Compressor discharge temp.(T5)	The display value is between 13~129 degree. If the temp. is lower than 13 degrees, the digital display tube displays "13". If the temp. is higher than 99 degrees, the digital display tube displays a single digit and a ten digit. (For example, if the digital display tube displays "0.5", it means the compressor discharge temp. is 105 degrees. If the digital display tube displays "1.6", it means the compressor discharge temp. is 116 degrees).		
10	AD value of current	The display value is a hex number.		
11	AD value of voltage			
12	Indoor unit running mode code	Off:0, Fan only 1,Cooling:2, Heating:3		
13	Outdoor unit running mode code	Off:0, Fan only 1,Cooling:2, Heating:3, Forced cooling:4		
14	EXV open angle	Actual data/4. If the value is higher than 99, the digital display tube displays a single digit and a ten digit. For example, if the digital display tube displays "2.0",it means the EXV open angle is 120*4=480p.).		
15	Frequency limit symbol	Bit7	Frequency limit caused by IGBT radiator	The display value is a hex number. For ex., the digital display tube displays 2A, then Bit5=1, Bit3=1, Bit1=1. It represents the frequency limit caused by T4, T3 and current.
		Bit6	Frequency limit caused by PFC	
		Bit5	Frequency limit caused by T4	
		Bit4	Frequency limit caused by T2	
		Bit3	Frequency limit caused by T3	
		Bit2	Frequency limit caused by T5	
		Bit1	Frequency limit caused by current	
Bit0	Frequency limit caused by voltage			
16	DC fan motor speed			
17	IGBT radiator temp.	The display value is between 30~120 degrees. If the temp. is lower than 30 degrees, the digital display tube displays "30". If the temp. is higher than 99 degrees, the digital display tube displays a single digit and a ten digit. (For example, if the digital display tube displays "0.5", it means the IGBT radiator temp. is 105 degrees. If the digital display tube displays "1.6", it means the IGBT radiator temp. is 116 degrees).		
18	Indoor unit number	The indoor unit can communicate well with the outdoor unit. General:1, Twins:2		
19	Evaporator pipe temp. T2 of 1# indoor unit	If the temp. is lower than 0 degree, the digital display tube displays "0". If the temp. is higher than 70 degrees, the digital display tube displays "70". If the indoor unit is not connected, the digital display tube displays: "--".		
20	Evaporator pipe temp. T2 of 2# indoor unit			
21	Evaporator pipe temp. T2 of 3# indoor unit			
22	1# Indoor unit capacity demand code	Actual data*HP*10 If the capacity demand code is higher than 99, the digital display tube displays a single digit and a tens digit. (For example, the digital display tube displays "5.0",it means the capacity demand is 15. If the digital display tube displays "60",it means the capacity demand is 6.0). If the indoor unit is not connected, the digital display tube displays: "--".		
23	2# Indoor unit capacity demand code			
24	3# Indoor unit capacity demand code			
25	Room temp. T1 of 1# indoor unit	If the temp. is lower than 0 degree, the digital display tube displays "0". If the temp. is higher than 70 degrees, the digital display tube displays "70". If the indoor unit is not connected, the digital display tube displays: "--".		
26	Room temp. T1 of 2# indoor unit			
27	Average room temp. T1			
28	Reason of stop			
29	Evaporator pipe temp. T2B of 1# indoor unit	If the temp. is lower than 0 degree, the digital display tube displays "0". If the temp. is higher than 70 degrees, the digital display tube displays "70". If the indoor unit is not connected, the digital display tube displays: "--".		
30	Evaporator pipe temp. T2B of 2# indoor unit			

EEPROM Parameter Error - Diagnosis and Solution (E0/F4)

Error Code	E0/F4
Malfunction decision conditions	Indoor or outdoor PCB main chip does not receive feedback from EEPROM chip.
Supposed Causes	<ul style="list-style-type: none"> • Installation mistake • PCB faulty

Troubleshooting

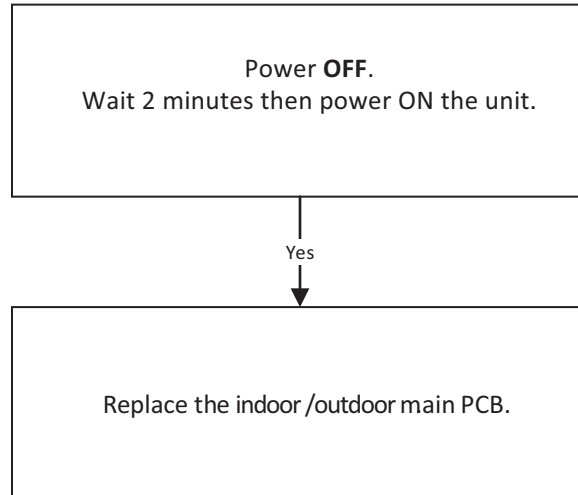

EEPROM: A read-only memory whose contents can be erased and reprogrammed using a pulsed voltage. For the location of the EEPROM chip, refer to the Fig. 18.

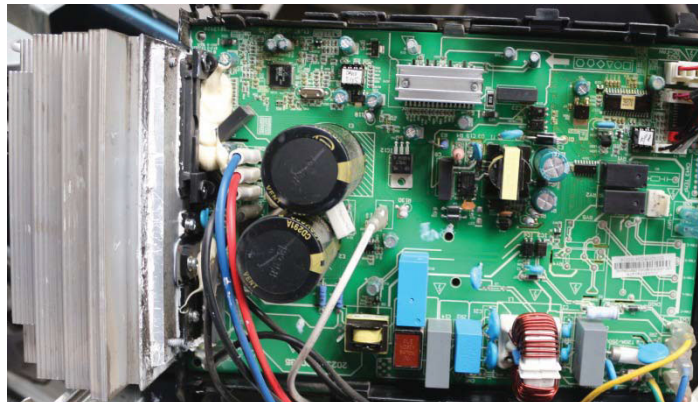

Fig. 18 — Outdoor PCB

Figure 18 is for illustration purposes **only** and may differ from your actual unit.

Overload Current Protection Diagnosis and Solution (F0)

Error Code	F0
Malfunction decision conditions	An abnormal current rise is detected by checking the specified current detection circuit.
Supposed Causes	<ul style="list-style-type: none"> • Power supply problems • System blockage • PCB faulty • Wiring mistake • Compressor malfunction

Troubleshooting

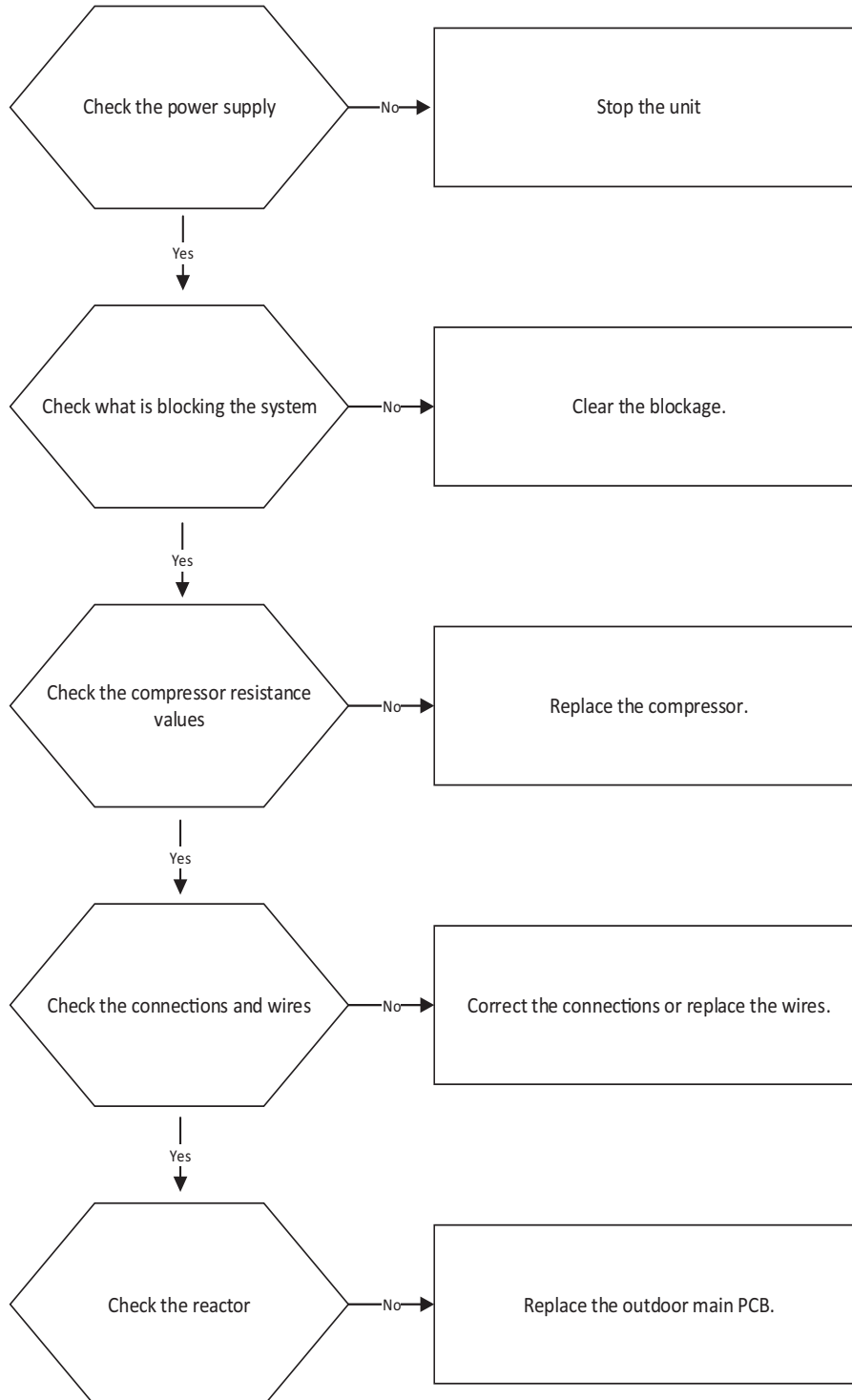

Indoor / Outdoor Unit's Communication Error - Diagnosis and Solution (E1)

Error Code	E1
Malfunction decision conditions	Indoor unit does not receive feedback from outdoor unit for 60 seconds, or the outdoor unit does not receive feedback from indoor unit for 120 seconds.
Supposed Causes	<ul style="list-style-type: none"> • Wiring mistake • Faulty indoor or outdoor PCB

Troubleshooting

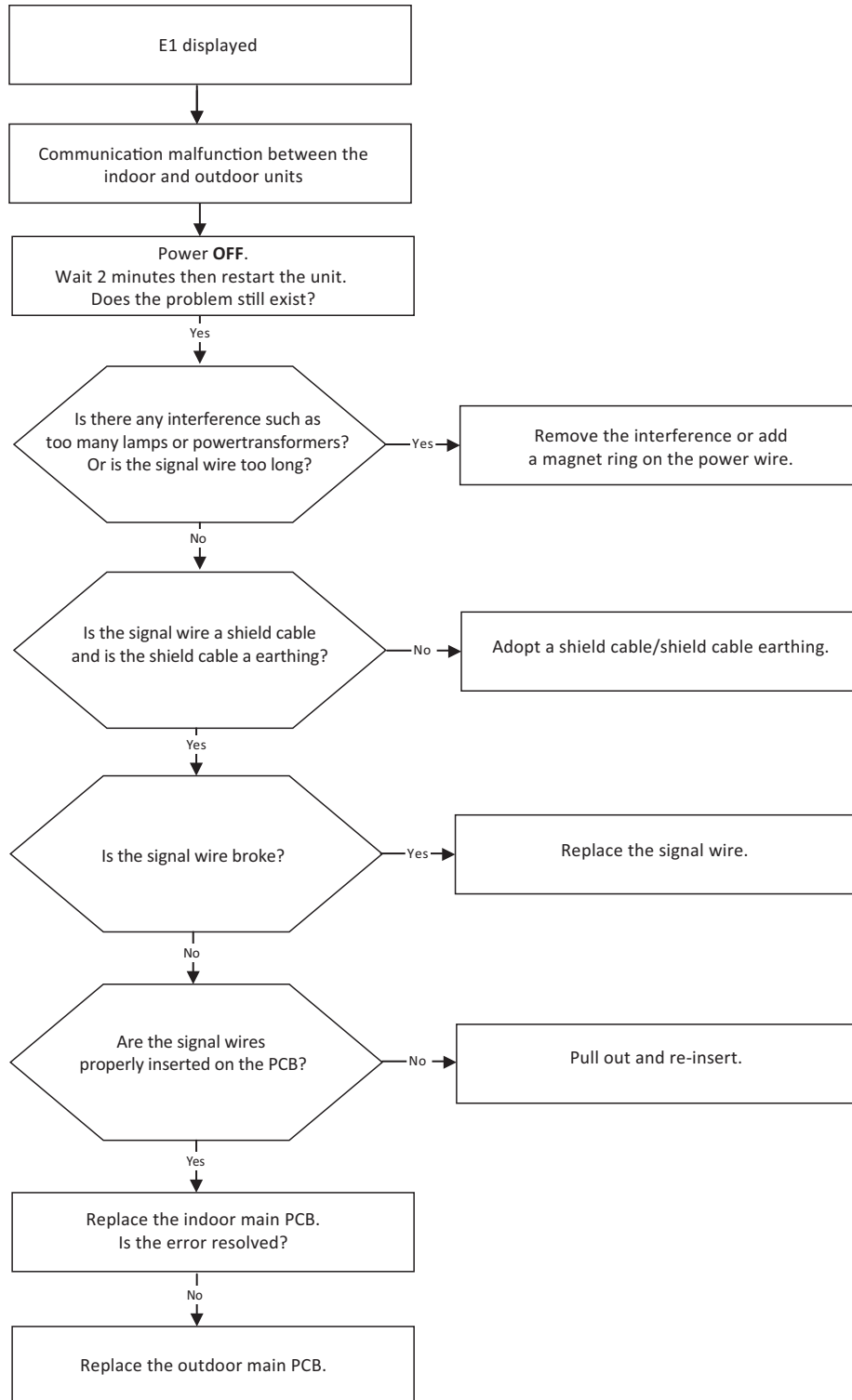

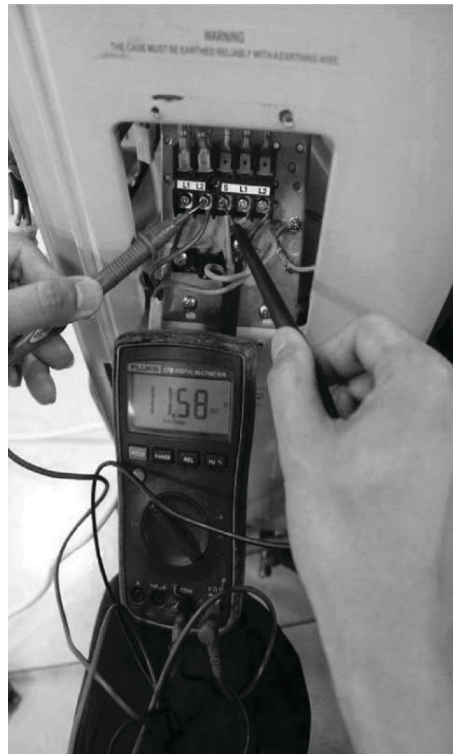

Fig. 19 — DC Voltage Test

Remark

Use a multimeter to test the DC voltage between the outdoor unit's L2 port and S ports (Fig. 19). The red pin of the multimeter connects with the L2 port while the black pin is for the S port. When the AC is running normally, the voltage moves alternatively between -50V to 50V.

If the outdoor unit has a malfunction, the voltage moves alternatively with a positive value. If the indoor unit has a malfunction, the voltage has a certain value.

Example: 10-13VDC small fluctuating amounts indicates indoor unit malfunction.

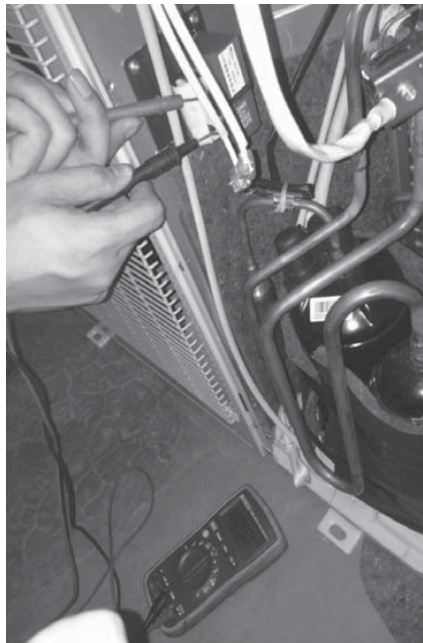

Fig. 20 — Reactor Resistance Test

Remark

Use a multimeter to test the reactor resistance that does not connect with the capacitor (Fig. 20). The normal values should be around zero ohm. Otherwise, the reactor has malfunctioned and needs to be replaced.

Index 1

Indoor or Outdoor DC Fan Motor (control chip is in the fan motor). Power on and when the unit is in standby, measure the voltage of pin-1 - pin3, pin4 -pin3 in the fan motor connector. If the value of the voltage is not in the range showing in the table below, the PCB has an issue and needs to be replaced.

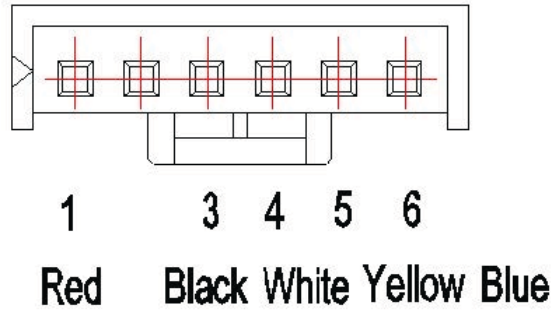

Fig. 21 — Control Chip

Table 17 — DC motor voltage input and output

NO.	COLOR	SIGNAL	VOLTAGE
1	Red	Vs/Vm	200~380V
2	---	---	---
3	Black	GND	OV
4	White	Vcc	13.5~16.5V
5	Yellow	Vsp	0~6.5V
6	Blue	FG	13.5~16.5V

Fan Speed is operating outside of the Normal Range (E3/F5)

Error Code	E3/F5
Description	When the indoor fan speed maintains a low speed (ex. 300RPM) or a speed that's too high (ex.1500RPM) for a certain time, the unit stops and the LED displays the failure (E3). When the outdoor fan speed registers below 200RPM or over 1500RPM for an extended period of time, the unit stops and the LED displays the failure (F5).
Supposed Causes	<ul style="list-style-type: none"> • Wiring mistake • Faulty fan assembly • Faulty fan motor • Faulty PCB

Troubleshooting

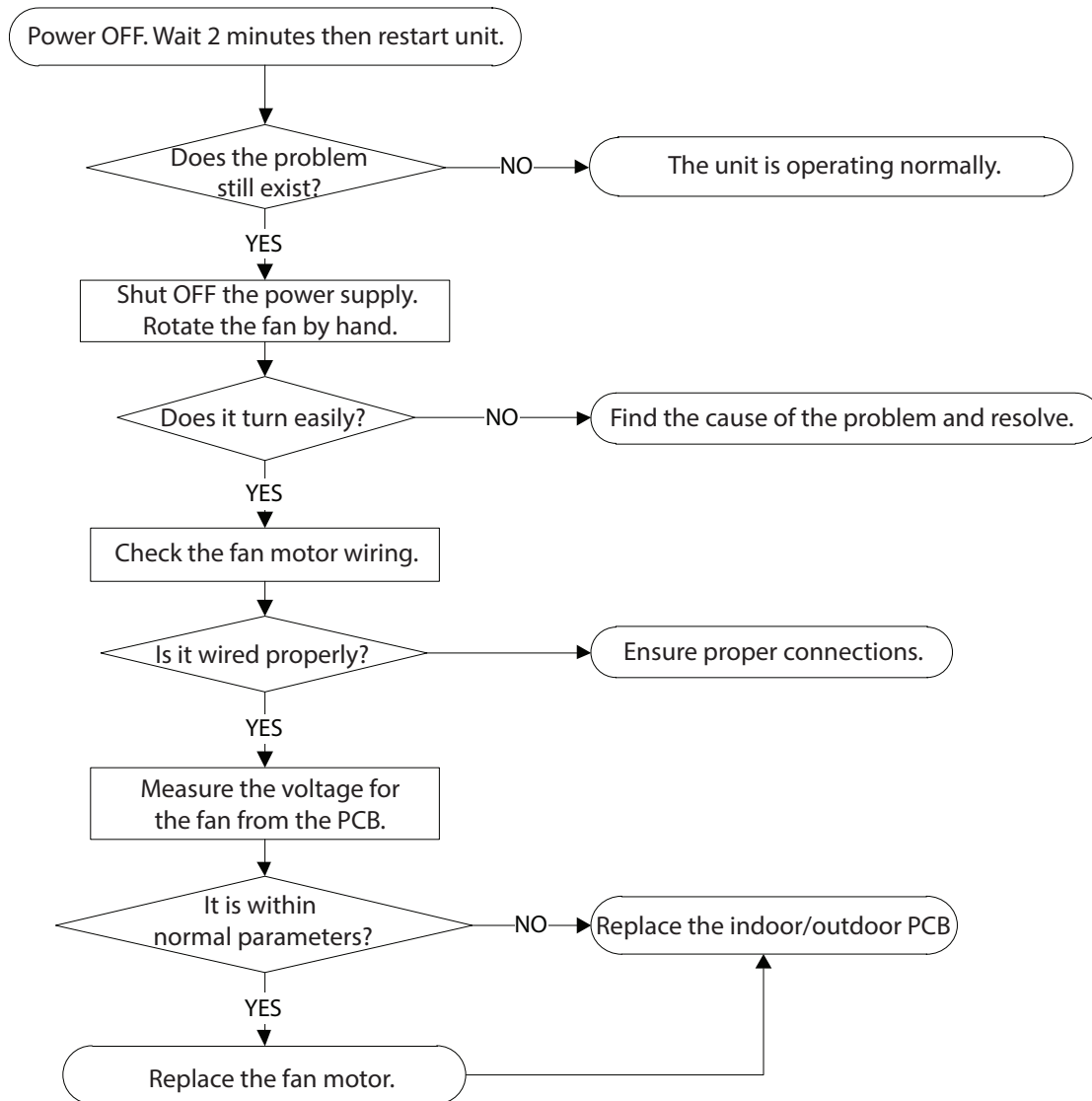

Open Circuit or Short Circuit of Temperature Sensor Diagnosis and Solution (E4/E5/F1/F2/F3)

Error Code	E4/E5/F1/F2/F3
Malfunction decision conditions	If the sampling voltage is lower than 0.06V or higher than 4.94V, the LED displays the failure.
Supposed Causes	<ul style="list-style-type: none"> • Wiring mistake • Sensor faulty

Troubleshooting

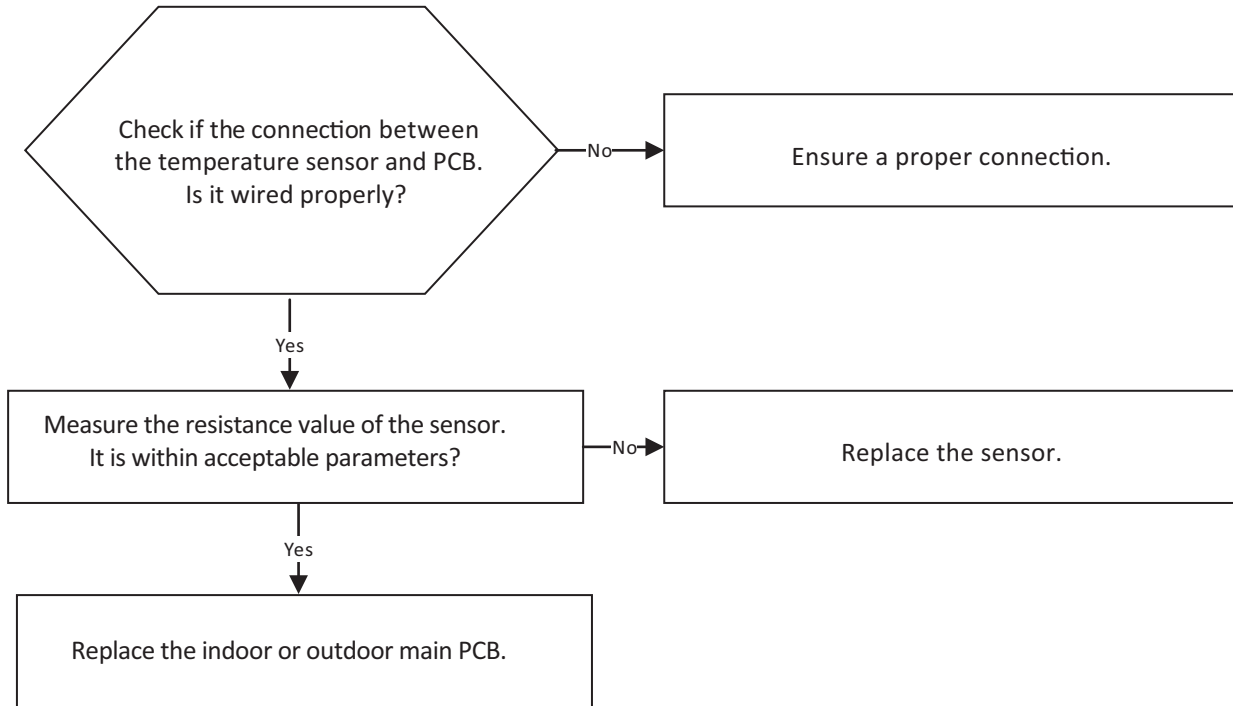
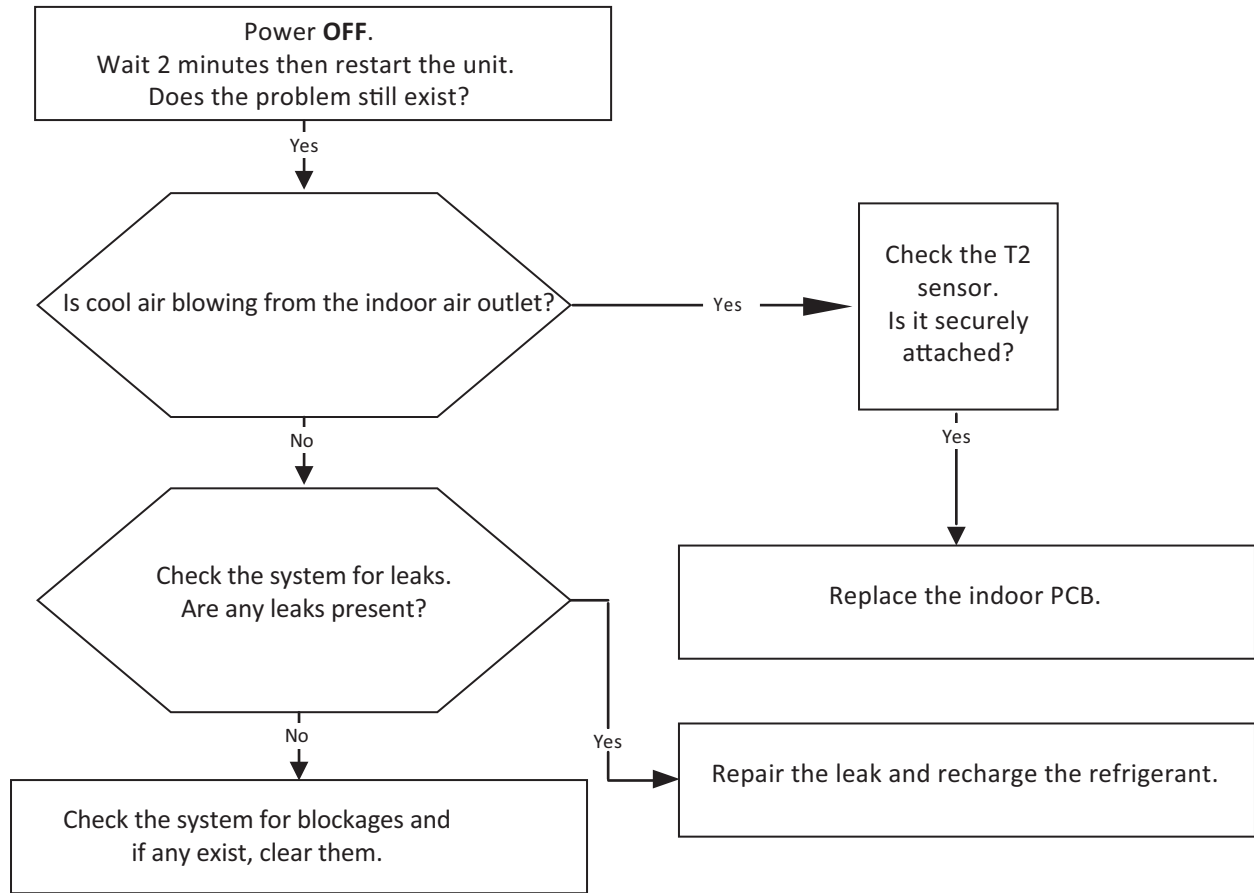

Fig. 22 — Test

Refrigerant Leakage Detection Diagnosis and Solution (EC)

Error Code	EC
Malfunction decision conditions	Define the evaporator coil temp. T2 of the compressor just starts running as Tcool. In the beginning 5 minutes after the compressor starts up, if $T2 < Tcool - 35.6^{\circ}F (Tcool - 2^{\circ}C)$ does not keep continuous 4 seconds and this situation happens 3 times, the display area shows "EC" and AC turns off.
Supposed Causes	<ul style="list-style-type: none"> • T2 sensor faulty • Indoor PCB faulty • System problems, such as leakage or blocking

Troubleshooting



IPM Malfunction or IGBT Over-strong Current Protection Diagnosis and Solution (PO)

Error Code	PO
Malfunction decision conditions	When the voltage signal that IPM sends to the compressor drive chip is abnormal, the LED displays "PO" and the AC turns off.
Supposed Causes	<ul style="list-style-type: none"> • Wiring mistake • IPM malfunction • Outdoor fan assembly faulty • Compressor malfunction • Outdoor PCB faulty

Troubleshooting

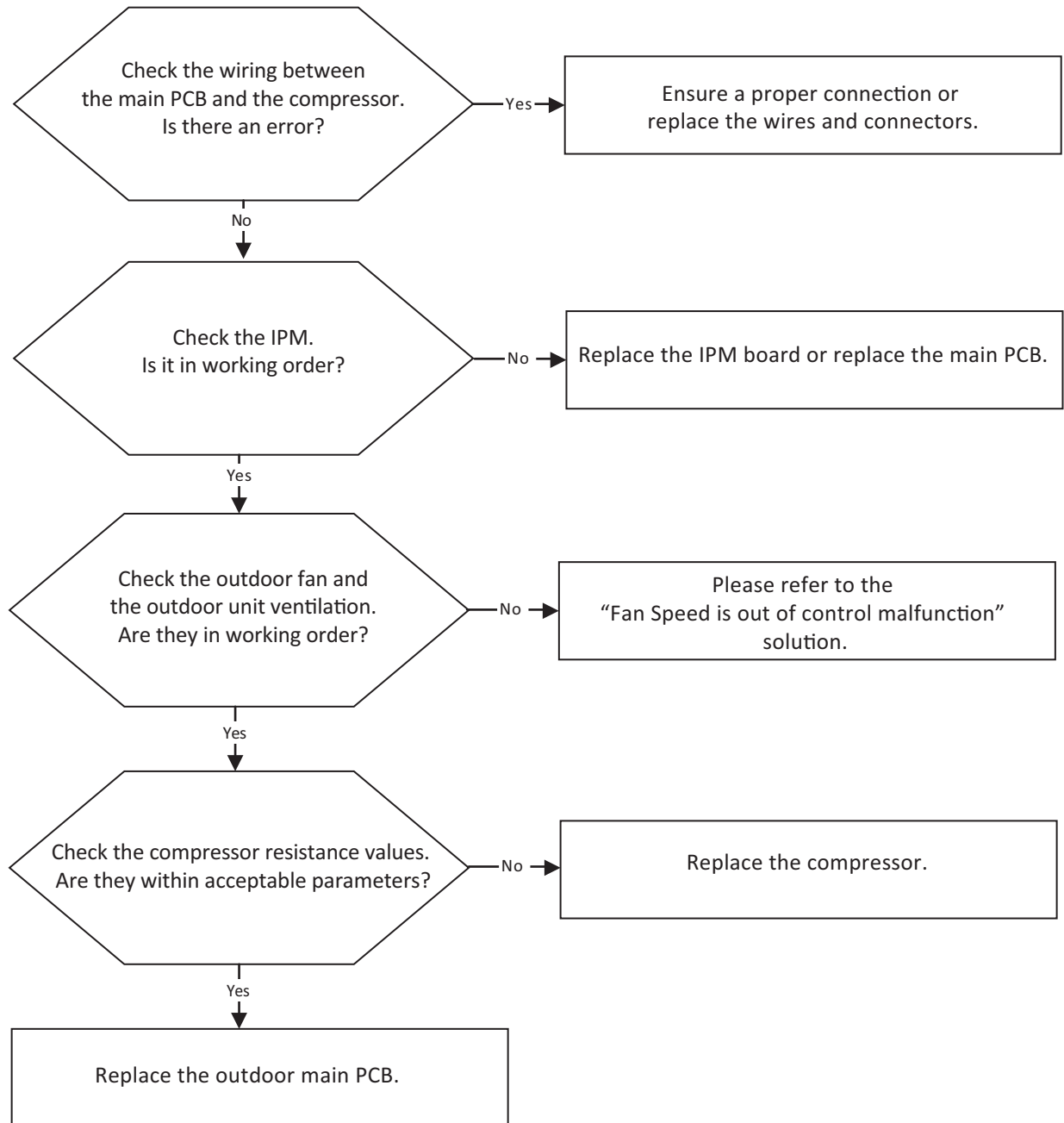

NOTE: In figures 23-24 the following is observed:

- U,V,W references the compressor connection point
- P references input voltage
- N references output voltage

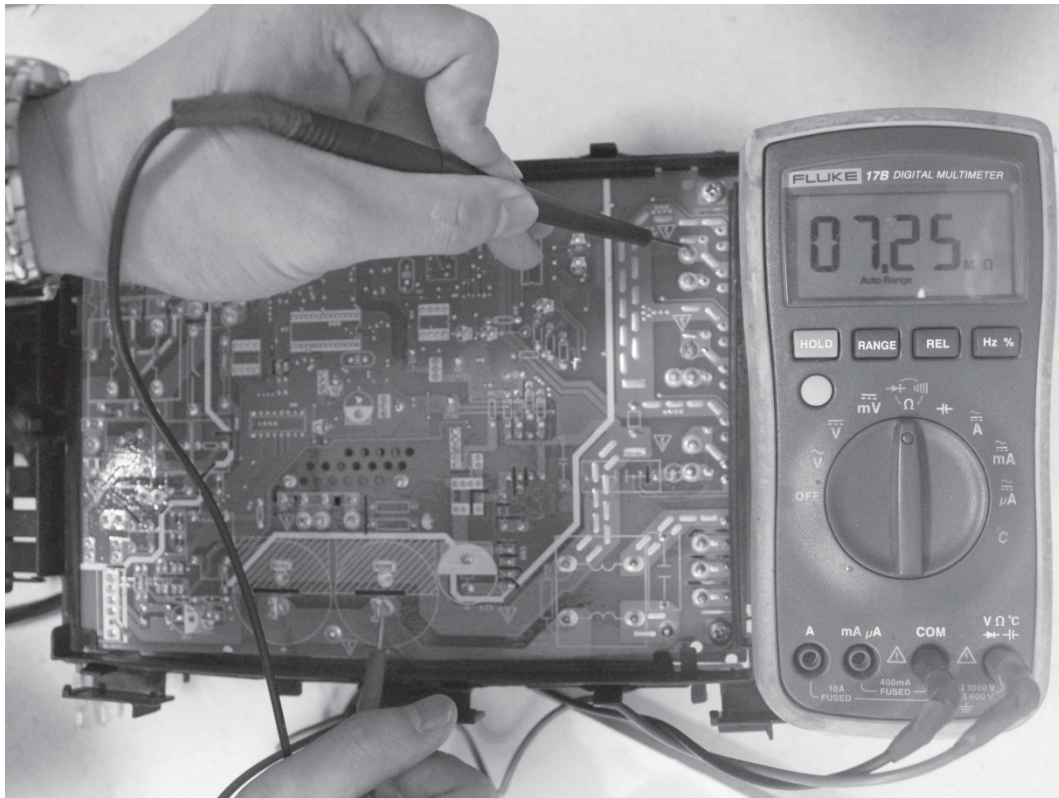

Fig. 23 — P-U

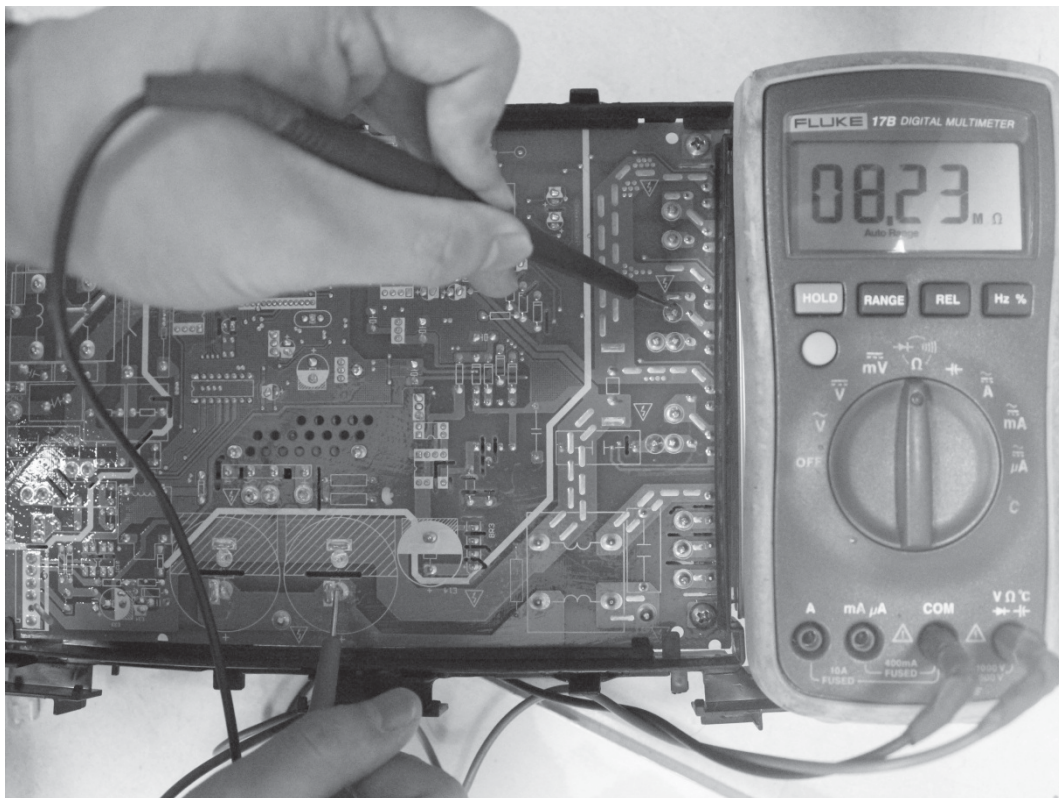

Fig. 24 — P-V

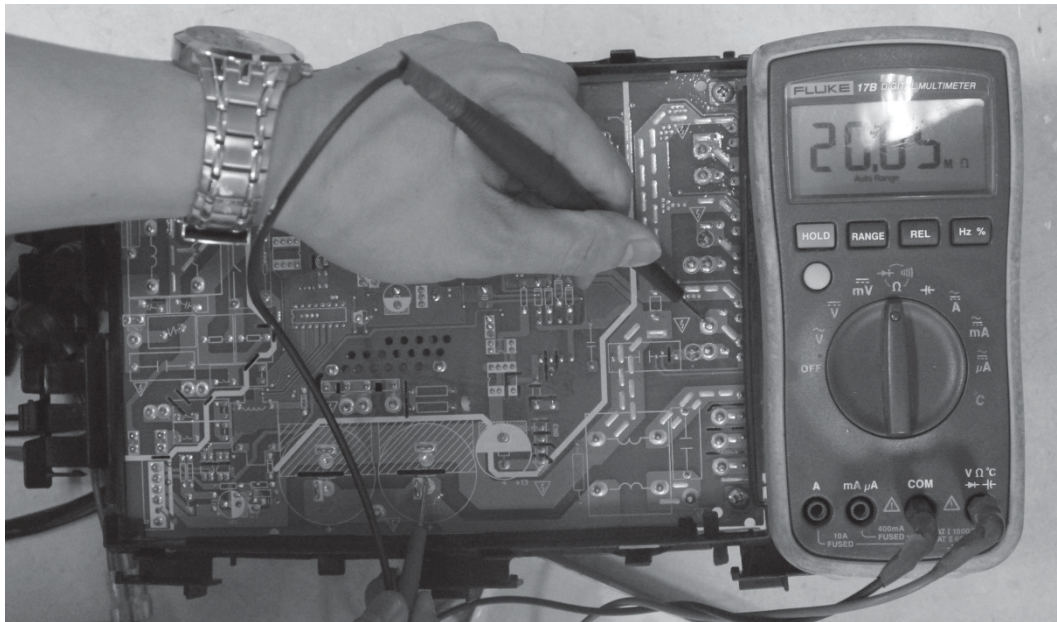

Fig. 25 — P-W

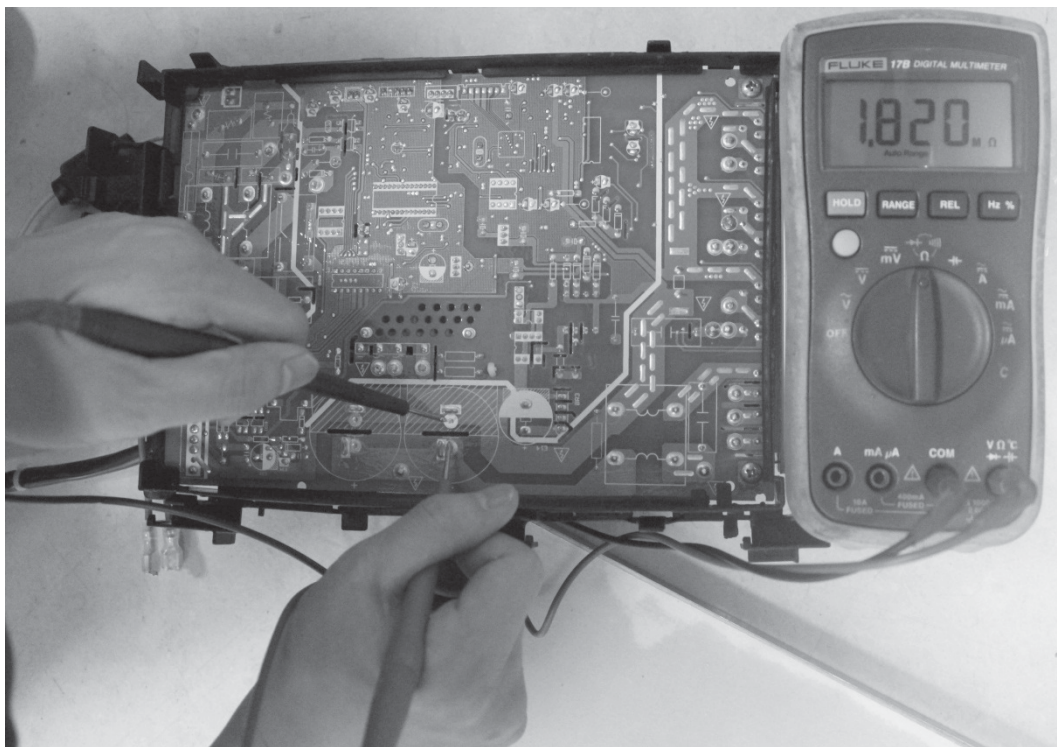

Fig. 26 — P-N

Over Voltage or Too Low Voltage Protection Diagnosis and Solution (P1)

Error Code	P1
Malfunction decision conditions	An abnormal current rise is detected by checking the specified current detection circuit.
Supposed Causes	<ul style="list-style-type: none"> • Power supply problems • System leakage or blockage • PCB faulty

Troubleshooting

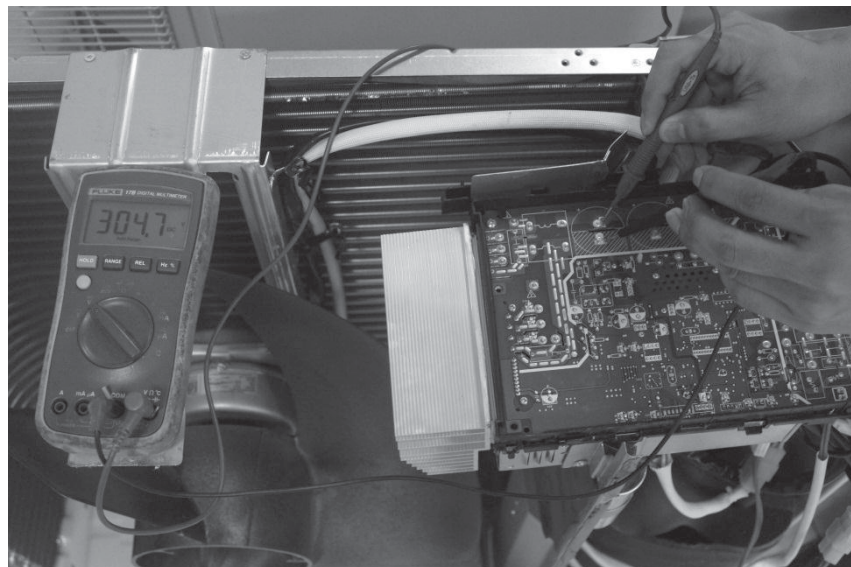
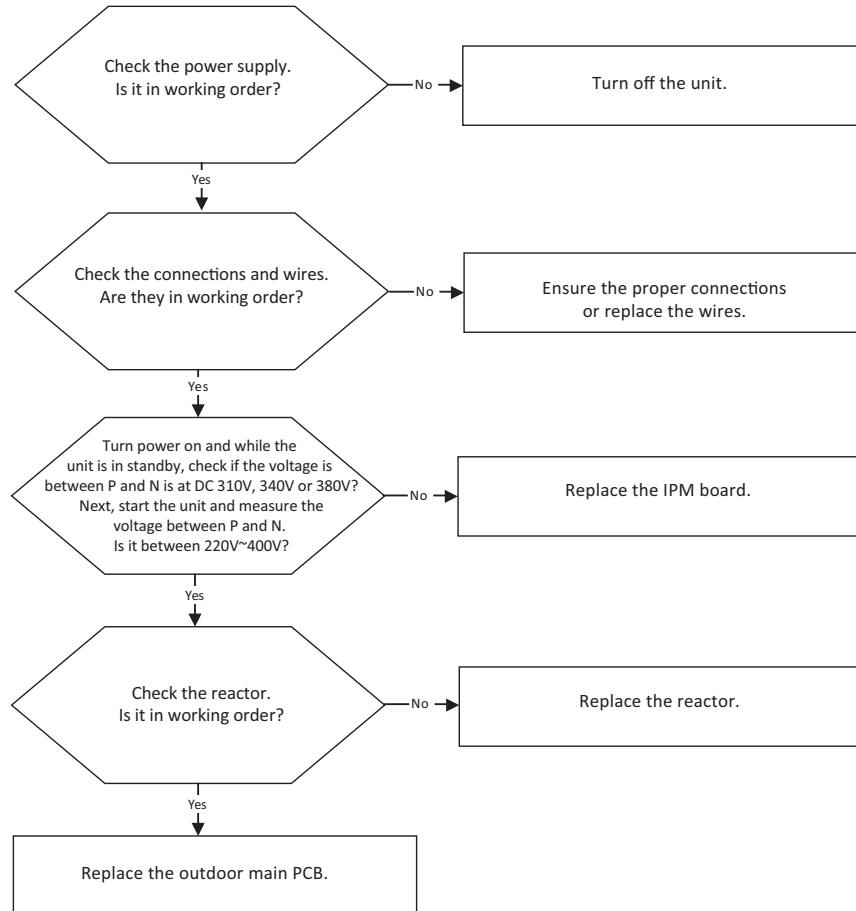
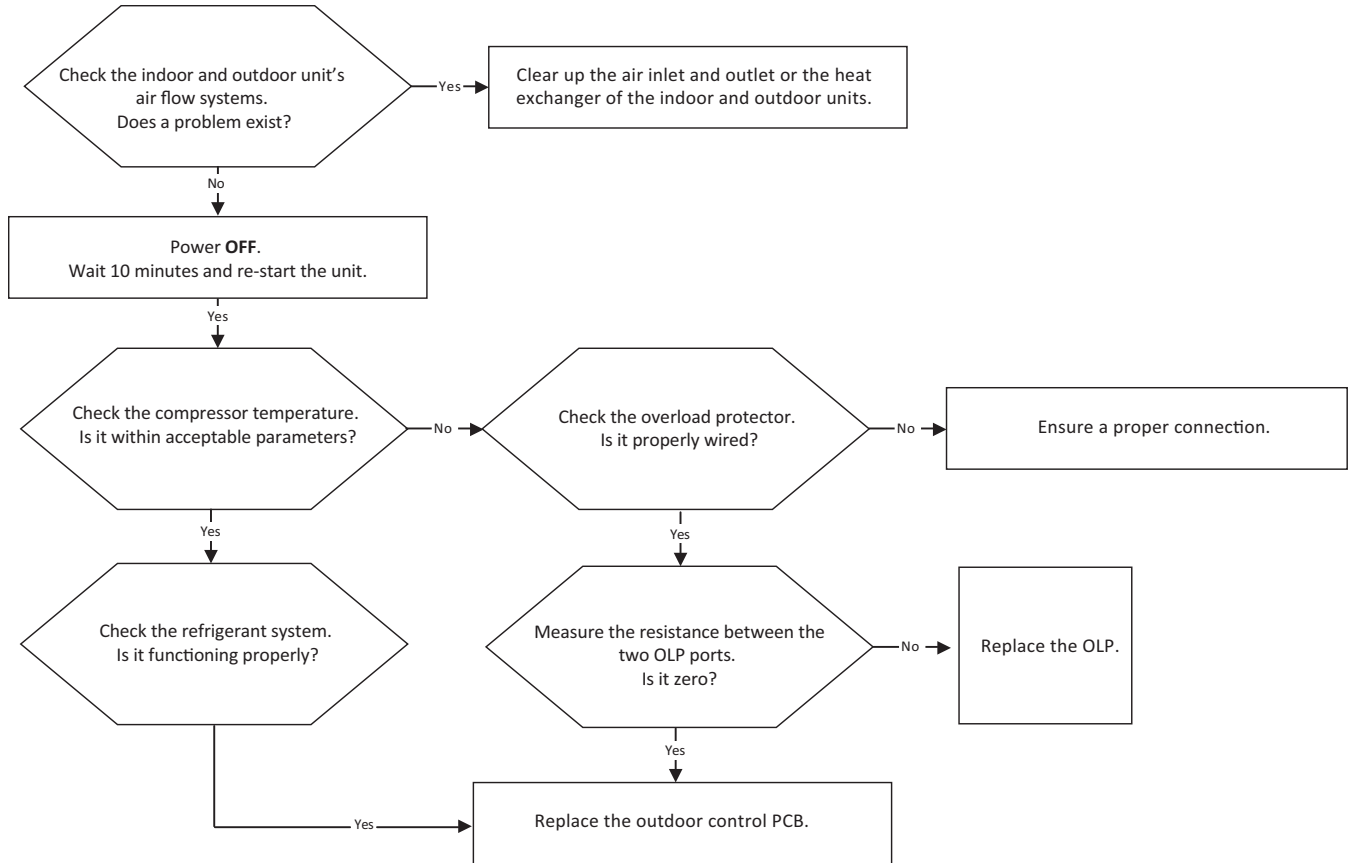

Fig. 27 — Test

High Temperature Protection of Compressor Top Diagnosis and Solution (P2)

Error Code	P2
Malfunction decision conditions	If the sampling voltage is not 5V, the LED displays the failure.
Supposed Causes	<ul style="list-style-type: none"> • Power supply problems • System leakage or block • PCB faulty

Troubleshooting



Inverter Compressor Drive Error Diagnosis and Solution (P4)

Error Code	P4
Malfunction decision conditions	An abnormal inverter compressor drive is detected by a special detection circuit, including communication signal detection, voltage detection, compressor rotation speed signal detection and so on.
Supposed Causes	<ul style="list-style-type: none"> • Wiring mistake • IPM malfunction • Outdoor fan assembly fault • Compressor malfunction • Outdoor PCB faulty

Troubleshooting

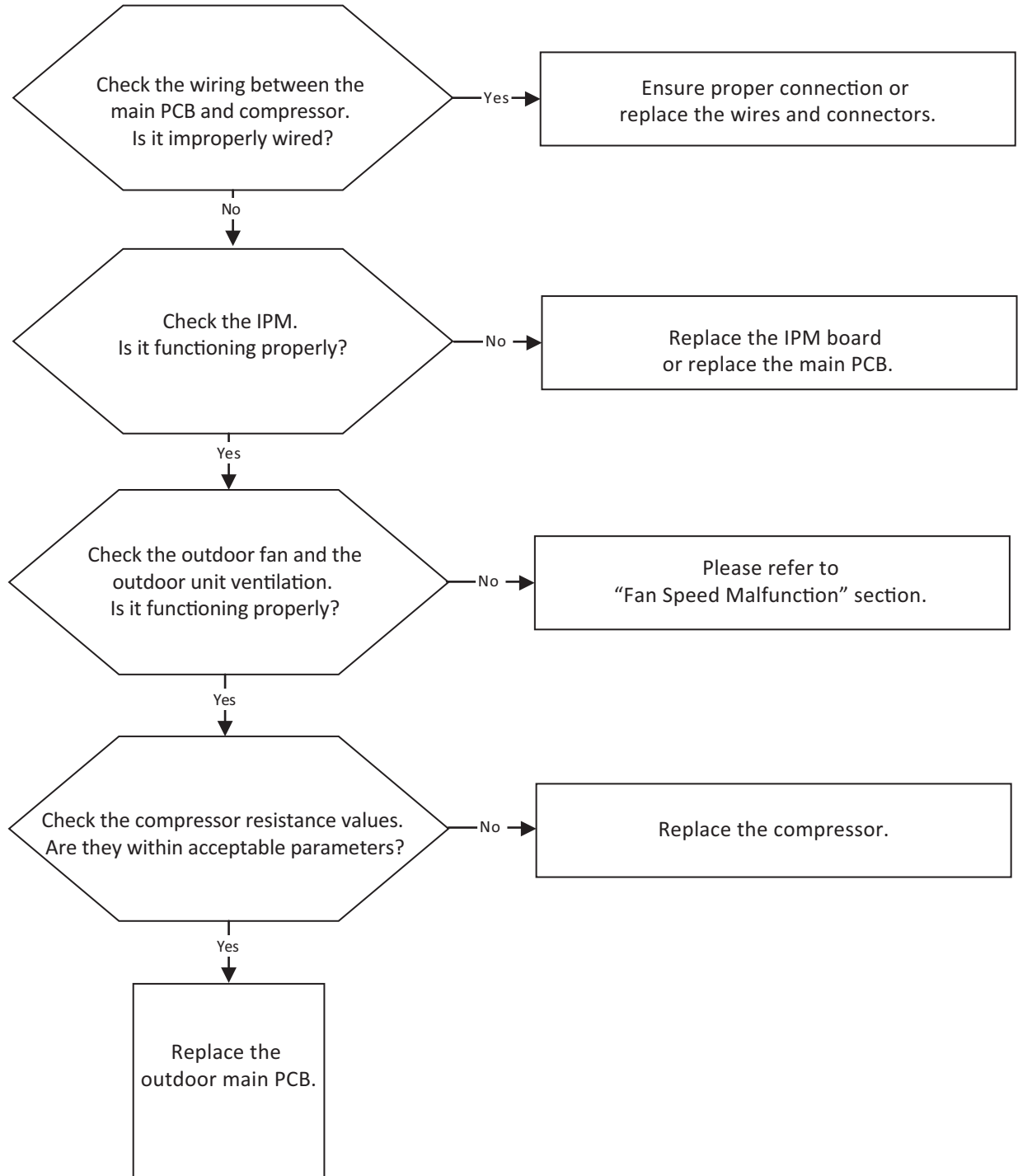

Outdoor IPM Module Temperature Sensor Malfunction Diagnosis and Solution (P7)

Error Code	P7
Malfunction decision conditions	If the sampling voltage is lower than 0.06V or higher than 4.94V, the LED displays a failure.
Supposed Causes	<ul style="list-style-type: none"> • Faulty wiring • Faulty sensor

Troubleshooting

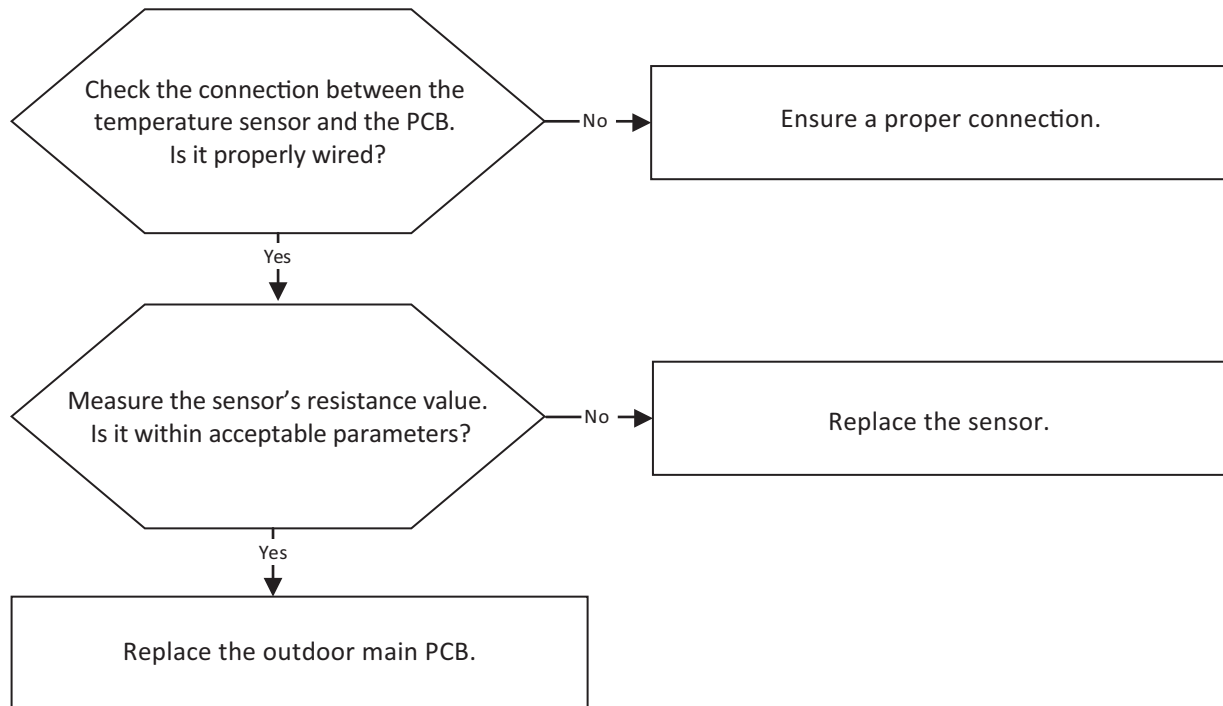

J0 Malfunction

Error Code	J0
Malfunction decision conditions	When the evaporator coil is more than 140°F(60°C), the unit stops. It starts up again only when the evaporator coil is less than 129°F(54°C).
Supposed Causes	<ul style="list-style-type: none"> • Faulty evaporator coil temperature sensor • Dirty heat exchanger • Faulty fan • Faulty PCB

Troubleshooting

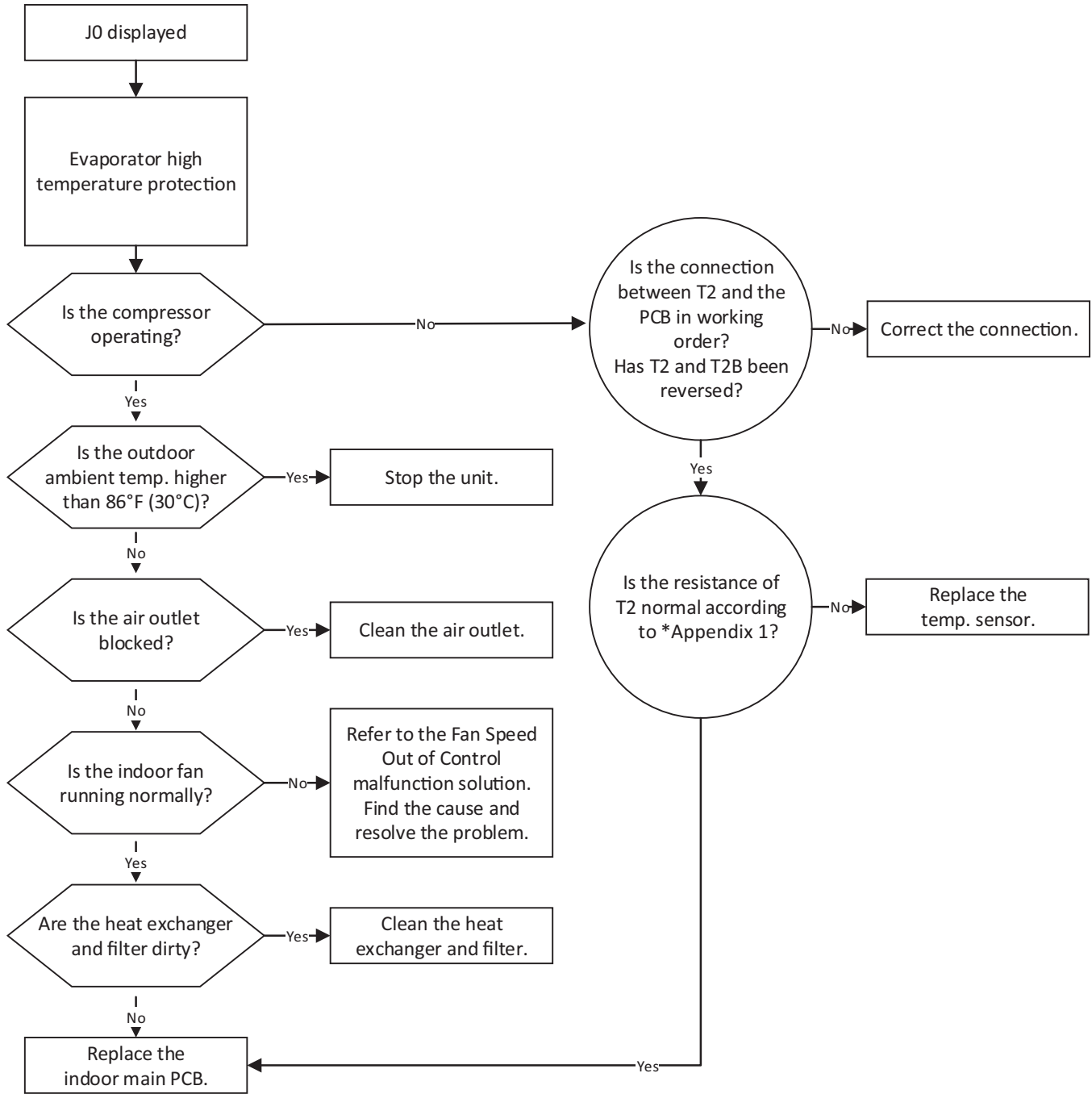

J1 Malfunction

Error Code	J1
Malfunction decision conditions	When the outdoor pipe temperature is more than 149°F(65°C), the unit stops. It starts up again only when the outdoor pipe temperature is less than 126°F(52°C).
Supposed Causes	<ul style="list-style-type: none"> • Faulty condenser temperature sensor • Dirty heat exchanger • System leakage or blockage

Troubleshooting

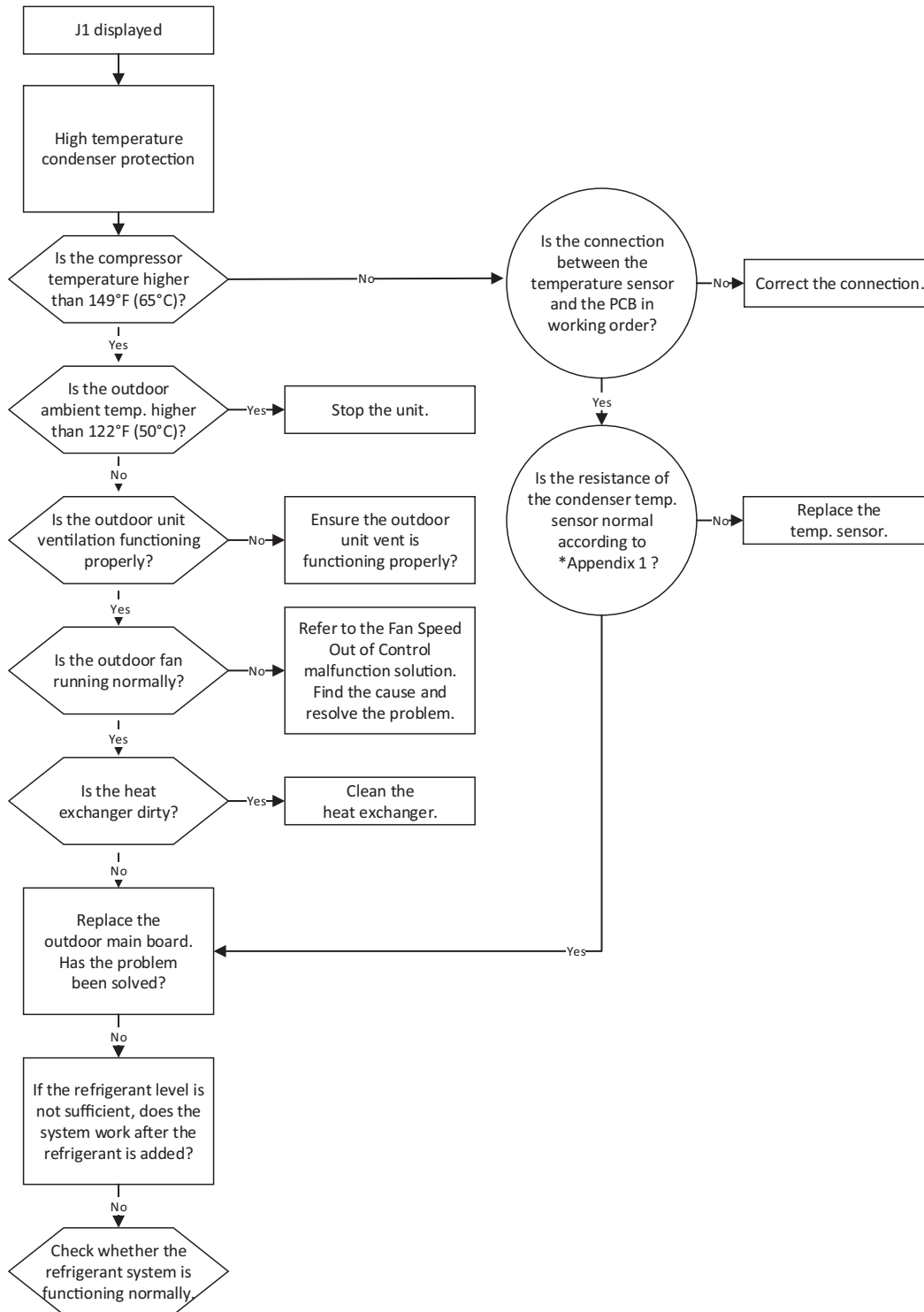

J2 Malfunction

Error Code	J2
Malfunction decision conditions	When the compressor discharge temperature (T5) is more than 115°C for 10 seconds, the compressor will stop and not restart until T5 is less than 90°C.
Supposed Causes	<ul style="list-style-type: none"> • Refrigerant leakage • Faulty wiring • Faulty discharge temperature sensor • Faulty outdoor PCB

Troubleshooting

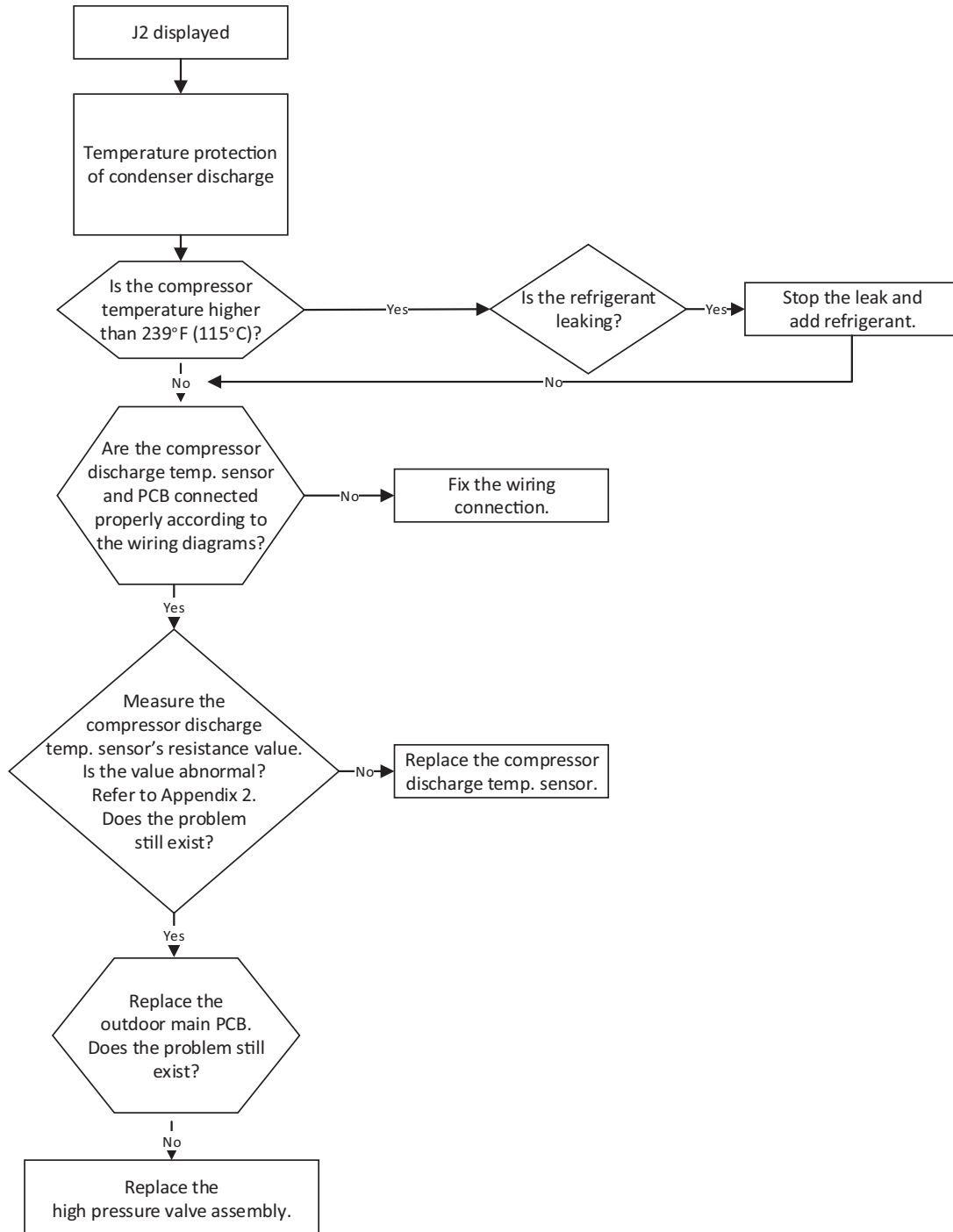

J3 Malfunction

Error Code	J3
Malfunction decision conditions	When the voltage signal that the IPM sends to the compressor is abnormal, the display LED shows “J3” and the unit turns off.
Supposed Causes	<ul style="list-style-type: none"> • Faulty wiring • Faulty IPM board • Faulty outdoor fan assembly • Compressor malfunction • Faulty outdoor PCB

Troubleshooting

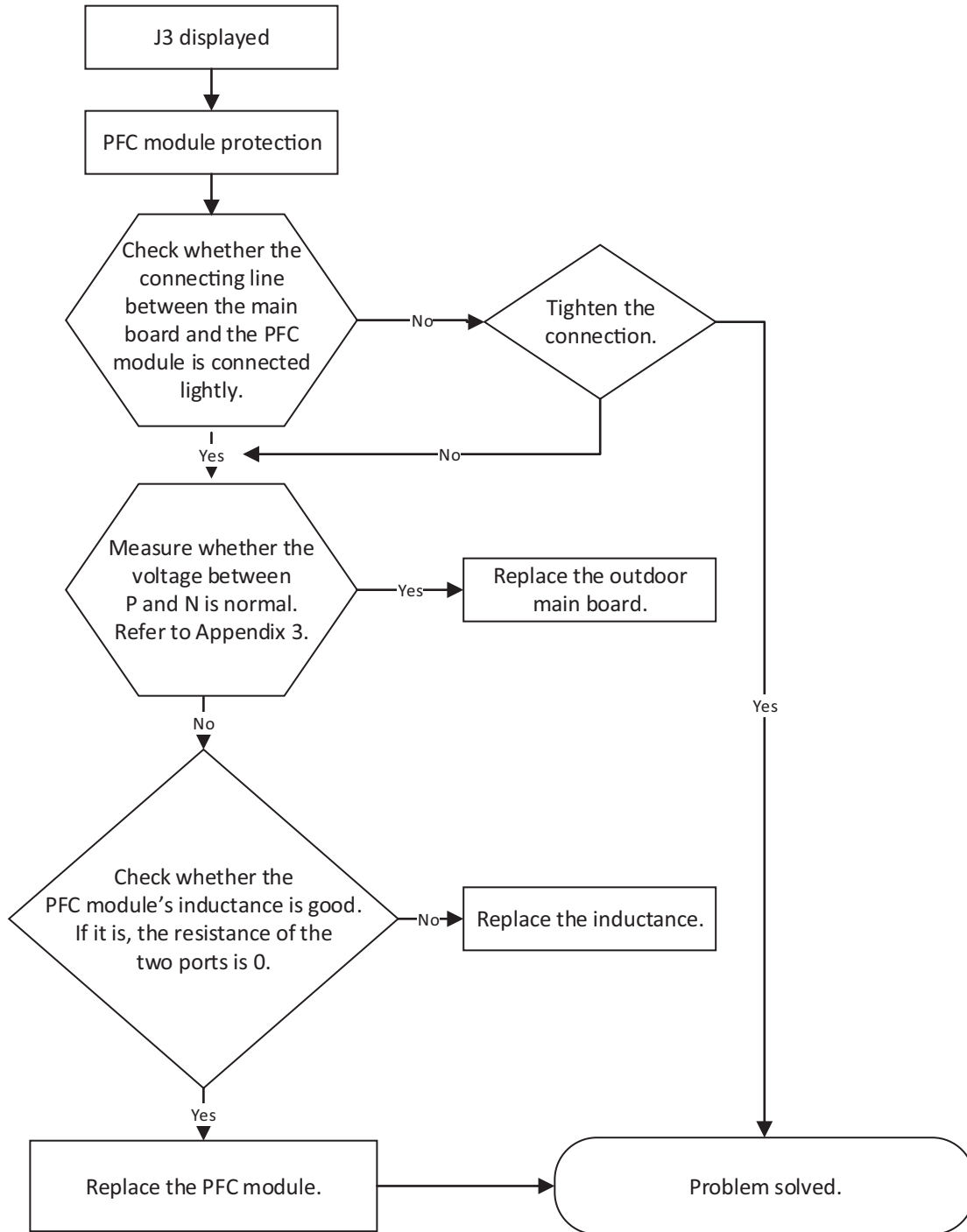

J4 Malfunction

Error Code	J4
Malfunction decision conditions	When the signal from the IPM to the Main Control Board and IPM Board is abnormal, the display LED shows "J4" and the unit turns off.
Supposed Causes	<ul style="list-style-type: none"> • Faulty wiring • Faulty IPM Outdoor board • Faulty Main Outdoor board • Faulty rectifier

Troubleshooting

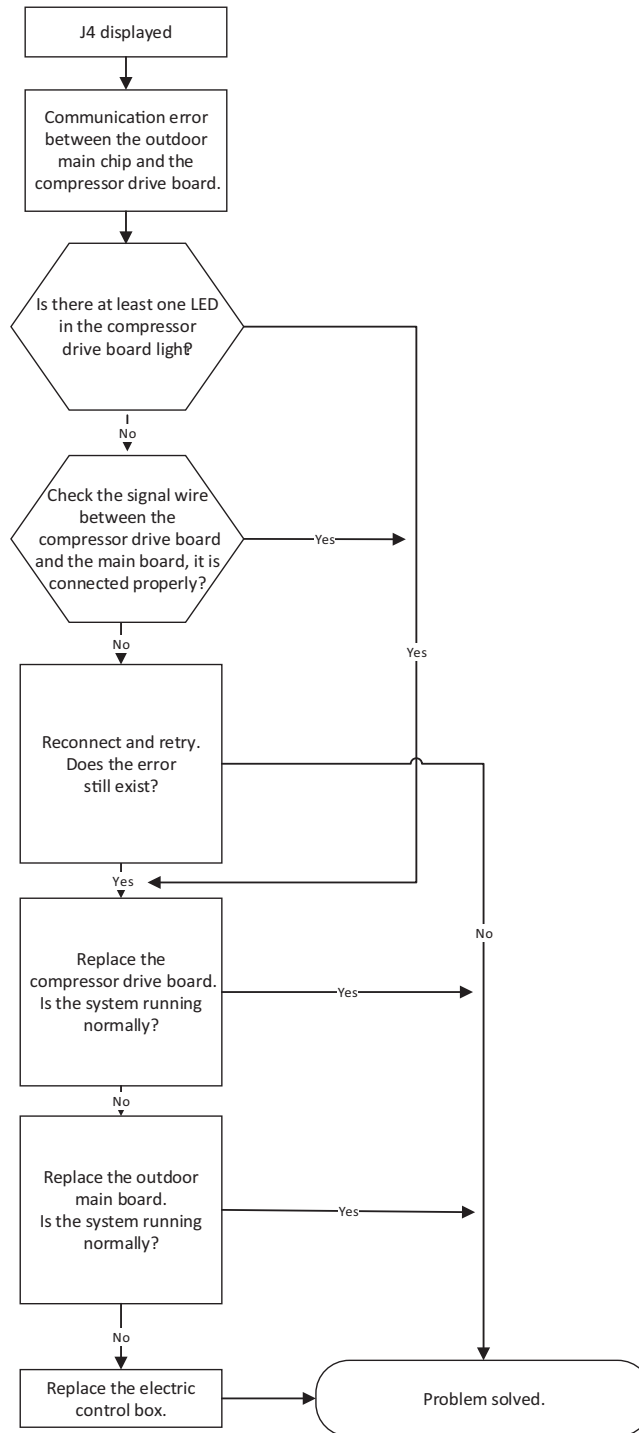

J5 Malfunction

Error Code	J5
Malfunction decision conditions	The sampling voltage is not 5V, the LED displays a failure code.
Supposed Causes	<ul style="list-style-type: none"> • Faulty wiring • Faulty overload protector • System blockage • Faulty outdoor PCB

Troubleshooting

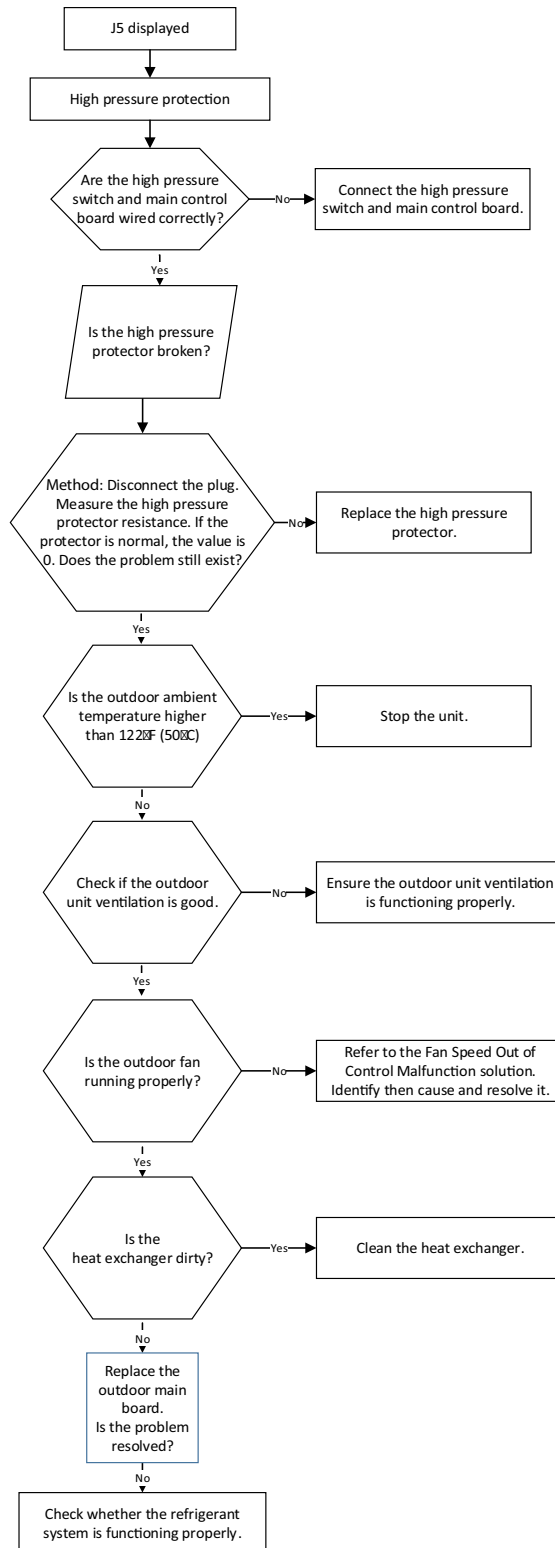

J6 Malfunction

Error Code	J6/P6
Malfunction decision conditions	If the sampling voltage is not 5V, the LED displays a failure code.
Supposed Causes	<ul style="list-style-type: none"> • Faulty wiring • Faulty overload protector • System blockage • Faulty outdoor PCB

Troubleshooting

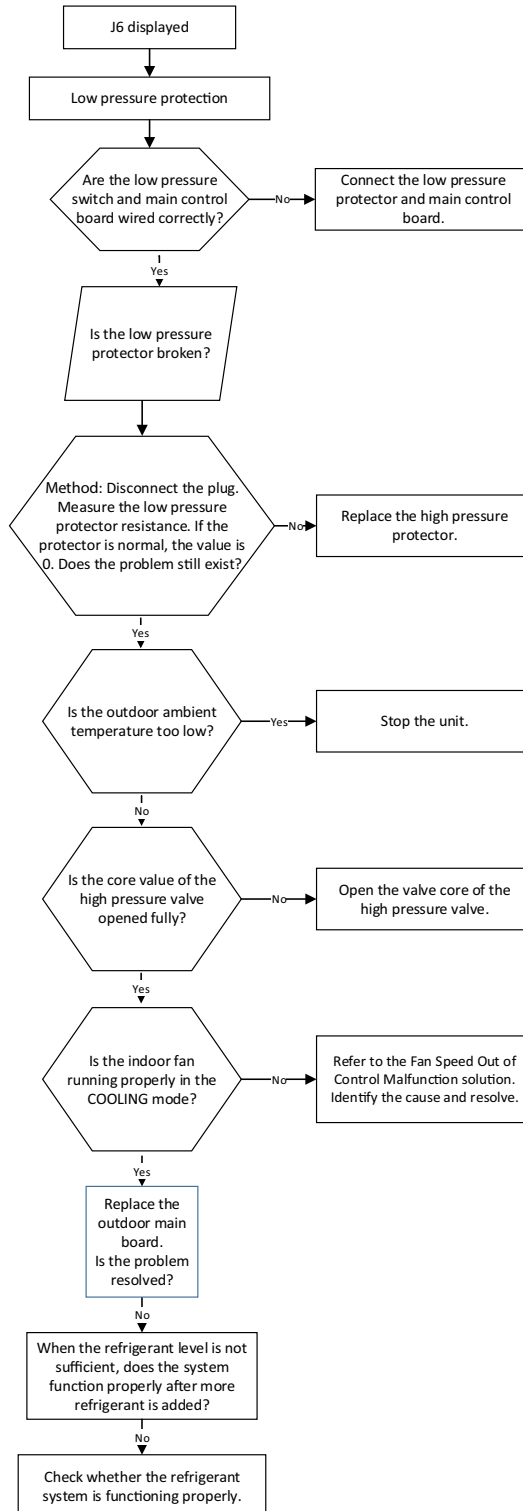

J8 Malfunction

Error Code	J8
Malfunction decision conditions	An abnormal voltage rise or drop is detected by checking the specified voltage detection circuit.
Supposed Causes	<ul style="list-style-type: none"> • Faulty or wrong power supply • Faulty wiring • Faulty bridge rectifier • Faulty IPM board

Troubleshooting

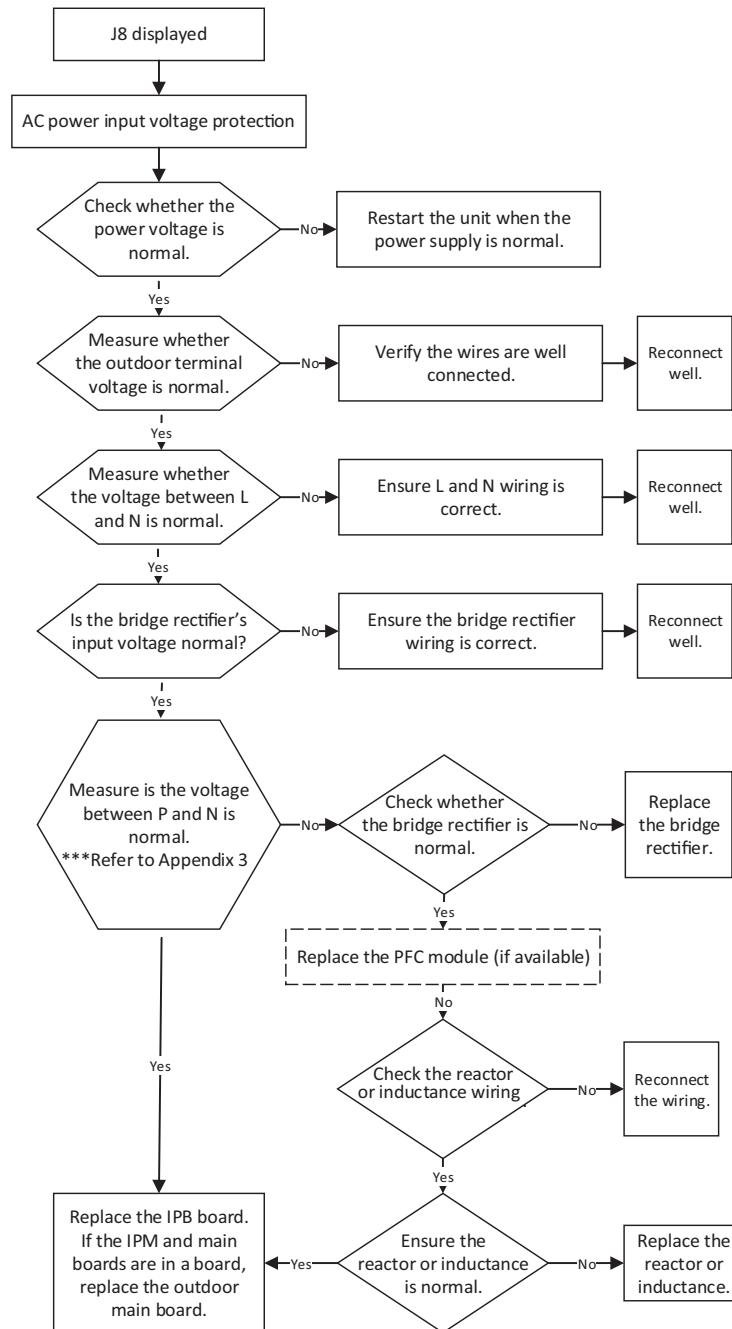

Main Parts Check

Temperature sensor checking

Disconnect the temperature sensor from PCB, measure the resistance value with a tester.

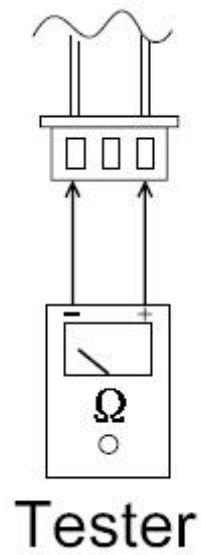

Temperature sensors:

- Room temp. (T1) sensor,
- Indoor coil temp. (T2) sensor,
- Outdoor coil temp. (T3) sensor,
- Outdoor ambient temp. (T4) sensor,
- Compressor discharge temp. (T5) sensor.

Measure the resistance value of each winding by using the multi-meter.

Compressor Checking

Measure the resistance value of each winding by using the tester.

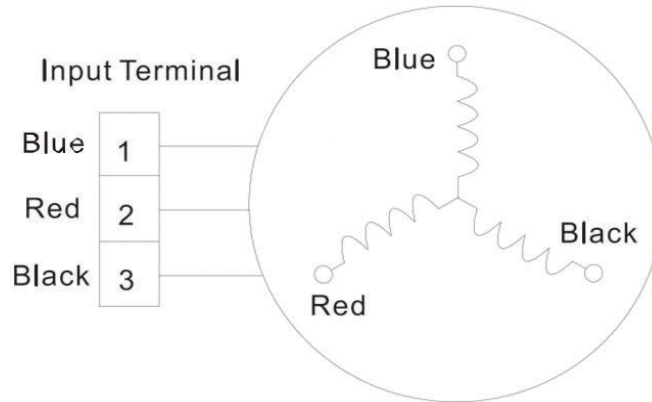

POSITION	NOMINAL RESISTANCE VALUE	
	ATF310D43UMT	ATQ420D1UMU
Blue - Red	0.65Ω	0.38Ω
Blue - Black		
Red - Blue		



IPM Continuity Check

Turn off the power, let the large capacity electrolytic capacitors discharge completely, and dismount the IPM. Use a digital tester to measure the resistance between P and UVWN; UVW and N.

DIGITAL TESTER		NORMAL RESISTANCE VALUE	DIGITAL TESTER		NORMAL RESISTANCE VALUE
(+)Red	(-)Black		(+)Red	(-)Black	
P	N	∞ (Several MΩ)	U	N	∞ (Several MΩ)
	U		V		
	V		W		
	W		(+)Red		

Pressure on Service Port

Cooling Charts (Cooling Mode)

F° C°	INDOOR TEMP	OUTDOOR TEMP.				
		75 (23.89)	85 (29.44)	95 (35)	105 (40.56)	115 (46.11)
BAR	70	8.2	7.8	8.1	8.6	10.1
BAR	75	8.6	8.3	8.7	9.1	10.7
BAR	80	9.3	8.9	9.1	9.6	11.2

PSI	70	119	113	117	125	147
PSI	75	124	120	126	132	155
PSI	80	135	129	132	140	162

MPA	70	0.82	0.78	0.81	0.86	1.01
MPA	75	0.86	0.83	0.87	0.91	1.07
MPA	80	0.93	0.89	0.91	0.96	1.12

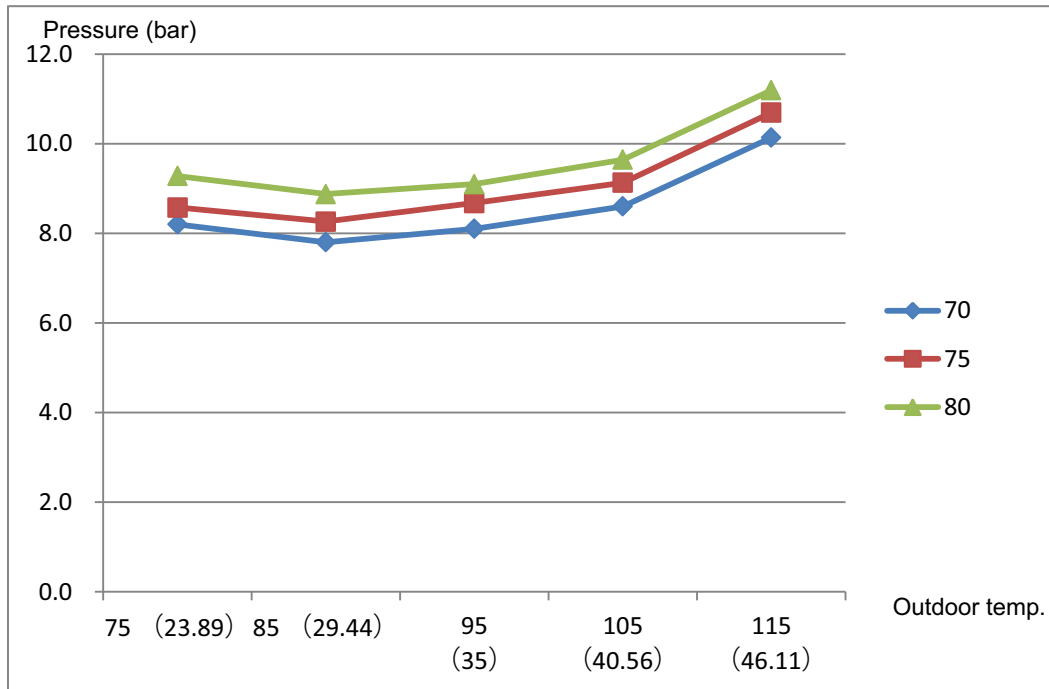

Pressure on Service Port (cont.)

Heating Charts (Heating Mode)



F° C°	INDOOR TEMP.	OUTDOOR TEMP.				
		57 (13.89)	47 (8.33)	37 (2.78)	27 (-2.78)	17 (-8.33)
BAR	55	30.3	28.5	25.3	22.8	20.8
BAR	65	32.5	30.0	26.6	25.4	23.3
BAR	75	33.8	31.5	27.8	26.3	24.9

PSI	55	439	413	367	330	302
PSI	65	471	435	386	368	339
PSI	75	489	457	403	381	362

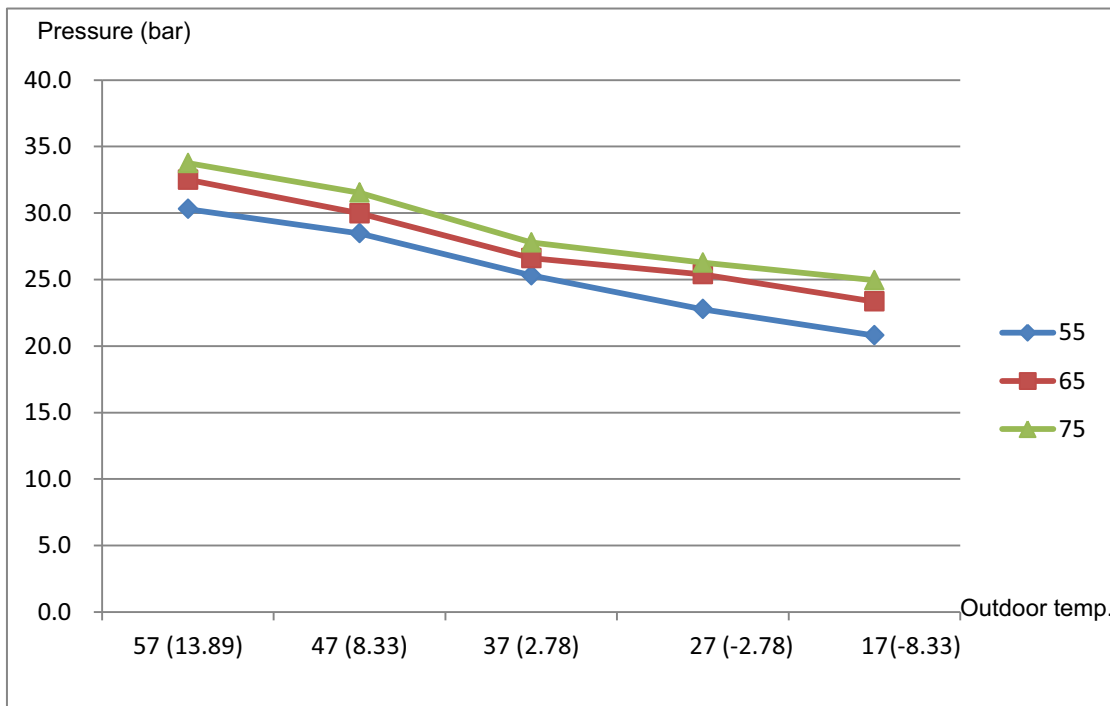
MPA	55	3.03	2.85	2.53	2.28	2.08
MPA	65	3.25	3.00	2.66	2.54	2.33
MPA	75	3.38	3.15	2.78	2.63	2.49

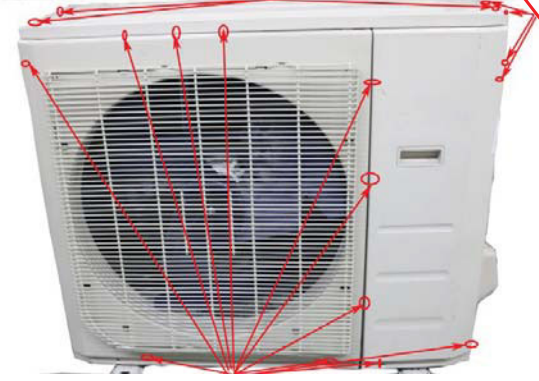

DISASSEMBLY INSTRUCTIONS SIZE 36

No.	Part name	Procedures	Remarks
1	Panel plate	<p>Remove the panel plate</p> <p>1) Stop the air conditioner and turn off the power breaker.</p> <p>2) Remove the big handle first, then remove the top cover (7 screws).</p> <p>3) Remove the front panel screws (11).</p> <p>(4) Remove the right side panel screws (13).</p>	<p>Big handle (4 screws)</p> <p>Screws of top panel (3screws, 1screws is under the big handle)</p>  <p>Front panel screws (11)</p> 

DISASSEMBLY INSTRUCTIONS SIZE 36 (CONT)

<p>2</p>	<p>Fan Assembly</p>	<p>Remove the fan assembly</p> <p>1) Use procedure 1 to remove the panel plate.</p> <p>2) Remove the nut securing the fan, then remove the fan.</p> <p>3) Unfix the hooks and remove the screws. Next, open the electronic control box cover.</p>	<p>The top photograph shows the internal components of the unit. Red arrows point to the 'Fan' (a blue propeller), the 'Electronic control box' (a black rectangular box), and the 'compressor' (a white cylindrical component). The middle photograph, labeled with a circled '2', is a close-up of the fan's central hub where a nut is being removed. The bottom photograph, labeled with a circled '3', shows the electronic control box cover with three red circles highlighting the locations where hooks and screws are being removed.</p>
----------	---------------------	---	--

DISASSEMBLY INSTRUCTIONS SIZE 36 (CONT)

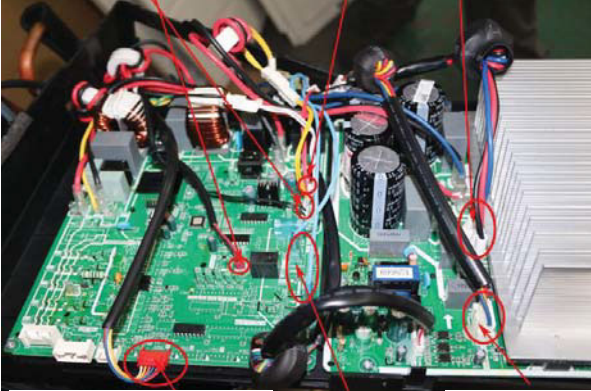
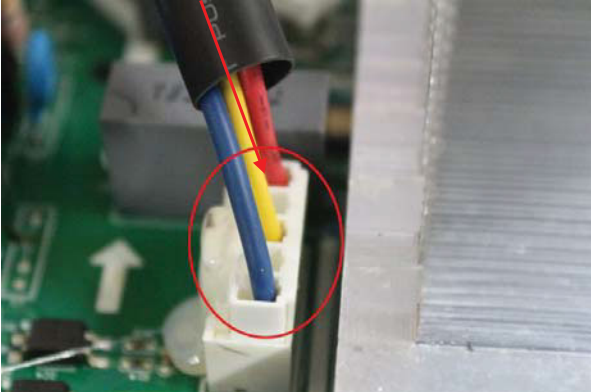
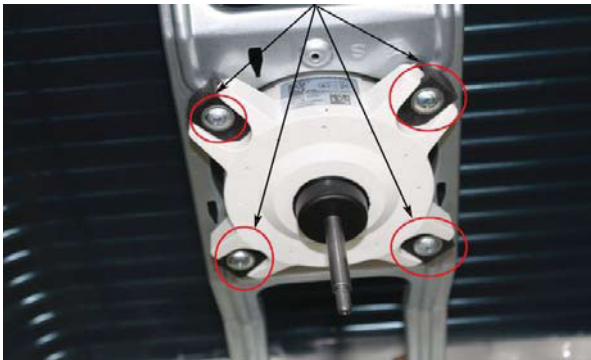
		<p>4) Disconnect the fan motor connector from the electronic control board.</p> <p>5) Remove the fan motor's screws (4) then remove the motor.</p>	<p>T3,T4,T5,sensor Pressure switch Compressor wire</p>  <p>Electronic expansion 4 way valve Motor wire</p> <p>④</p>  <p>⑤</p> 
--	--	--	---

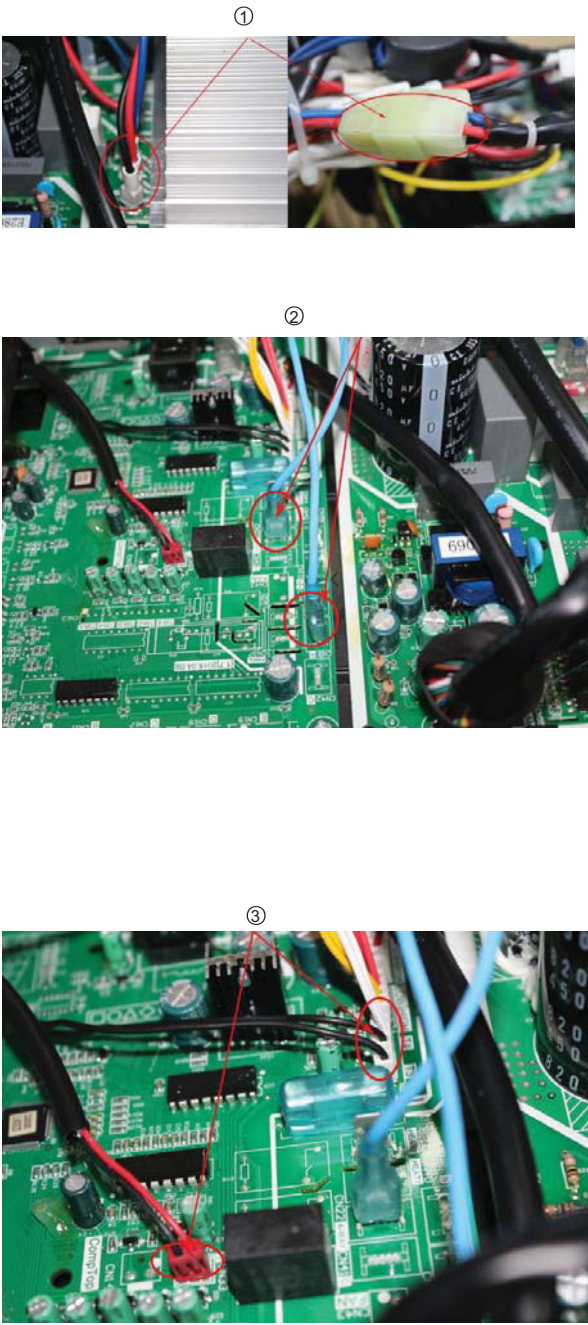

DISASSEMBLY INSTRUCTIONS SIZE 36 (CONT)

<p>3</p>	<p>Electrical parts</p>	<p>Remove the electrical parts</p> <ol style="list-style-type: none"> 1) After completing steps in sections 1 and 2, remove the compressor connector. 2) Pull out the two blue wires connected with the 4-way valve. 3) Pull out the condenser coil temp. sensor (T3) connectors, outdoor ambient temp. sensor (T4), and the discharge temp. sensor (T5). 	 <p>The first photograph, labeled with a circled '1', shows a close-up of a compressor connector being removed from the PCB. The second photograph, labeled with a circled '2', shows two blue wires being pulled out from the board. The third photograph, labeled with a circled '3', shows three temperature sensors (T3, T4, T5) being removed from the board.</p>
----------	-------------------------	--	---

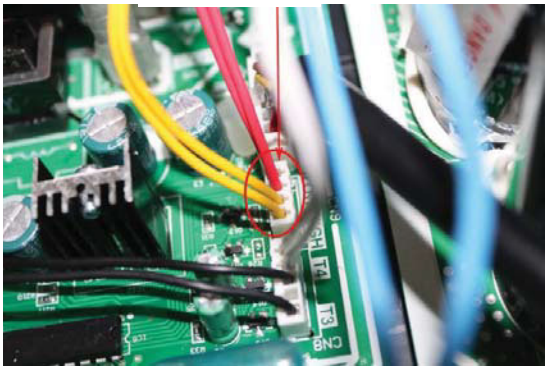
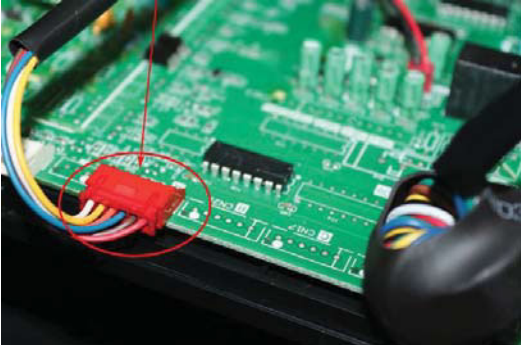
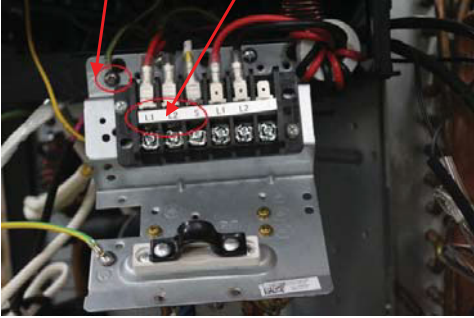
DISASSEMBLY INSTRUCTIONS SIZE 36 (CONT)

		<p>4) Disconnect the pressure switch connector.</p> <p>5) Disconnect the electronic expansion valve from the control board.</p> <p>6) Remove the ground wires.</p> <p>7) Remove the wires (1,2,3 or L1,L2, S). Next, remove the electronic control box.</p>	  
--	--	---	--

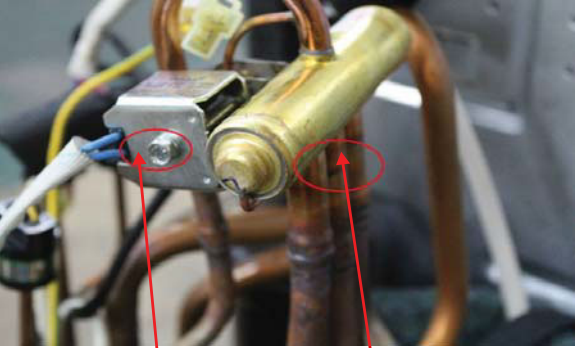

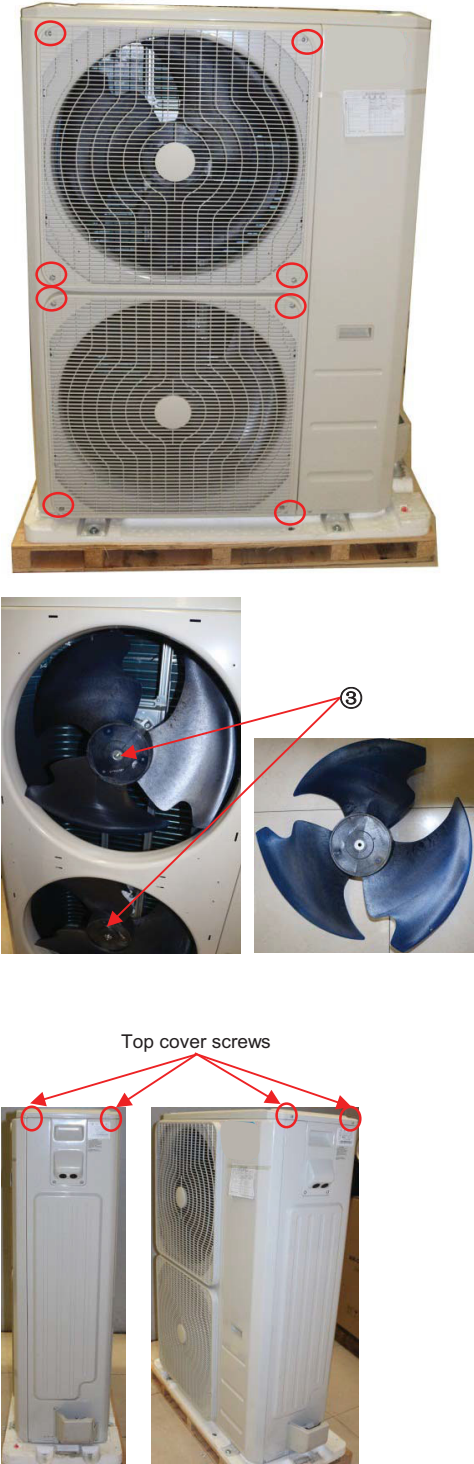

DISASSEMBLY INSTRUCTIONS SIZE 36 (CONT)

<p>4</p>	<p>4-Way Valve</p>	<p>Remove the 4-way valve</p> <ol style="list-style-type: none"> 1) Complete the steps in sections 1 and 3. 2) Recover refrigerant from the refrigerant coil. 3) Remove the coil screw then remove the coil. 4) Detach the 4-way valve's and pipe's welded parts. 5) Remove the 4-way valve assembly. 	<p>The picture of the 4-way may differ from your actual valve.</p>  <p>③ ④</p>
<p>5</p>	<p>Compressor</p>	<p>Remove the compressor</p> <ol style="list-style-type: none"> 1) After completing the steps in sections 1 and 3 recover the refrigerant from the refrigerant circuit. 2) Remove the discharge pipe and the suction pipe with a burner. 3) Remove the hex nuts and washers securing the compressor on the bottom plate. 4) Lift the compressor from the base pan assembly. 	 <p>②</p> <p>③</p>

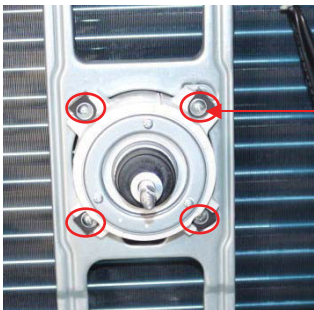

DISASSEMBLY INSTRUCTIONS SIZE 48-58

No.	Part name	Procedures	Remarks
1	Fan assembly	<p>Remove the fan assembly</p> <ol style="list-style-type: none"> 1) Stop the air conditioner and turn off the power breaker. 2) Remove the air outlet grille screws (8). 3) Remove the hex nut securing the fan. 4) Remove the fan. 5) Remove the top cover screws (4) then remove the top cover. 	 <p>The 'Remarks' column contains three images. The top image shows a full view of the outdoor unit with red circles around 8 screws on the air outlet grille. The middle image is a close-up of the fan assembly with a red circle around a hex nut. The bottom image shows two views of the unit with the top cover removed, with red circles and arrows pointing to 4 screws on the top cover.</p>

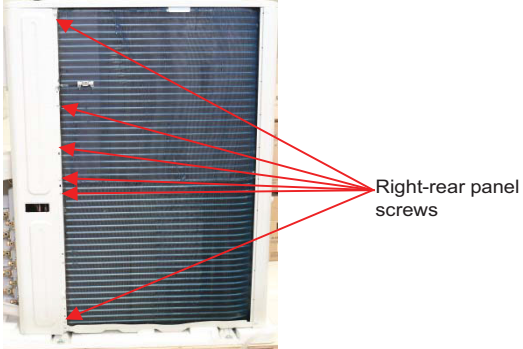

DISASSEMBLY INSTRUCTIONS SIZE 48-58 (CONT)

		<p>6) Remove the right front side screw (1) and the right front side panel.</p> <p>7) Disconnect the fan motor connectors FAN (3p, white) and FAN2 (3p, white) from the DC motor driver board.</p> <p>8) Remove the fan motor after unfastening the securing screws.</p>	  
<p>2</p>	<p>Panel plate</p>	<p>Remove the panel plate.</p> <p>1) Remove the big handle screws (2) and the water collector screws (2).</p> <p>2) Remove the terminal board screws (2) and the right-rear panel screws (7) and remove the right-rear panel.</p>	 <p>Big handle screws</p> <p>Water collector screws</p> <p>Right-rear screws</p>

DISASSEMBLY INSTRUCTIONS SIZE 48-58 (CONT)

			
<p>3</p>	<p>Electrical parts</p>	<p>Remove the electrical parts</p> <ol style="list-style-type: none"> 1) Complete steps 5 - 6 in section 1 and section 2. 2) Disconnect the fan motor connector (5p, white) from the IPM board. 3) Disconnect the following eight (8) connection wires and connectors between the IPM and the other parts. 	 <p>IPM board PCB board DC Fan Driver board</p>  <p>②</p>

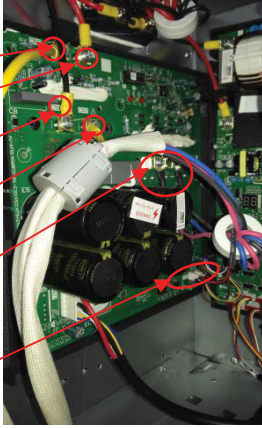

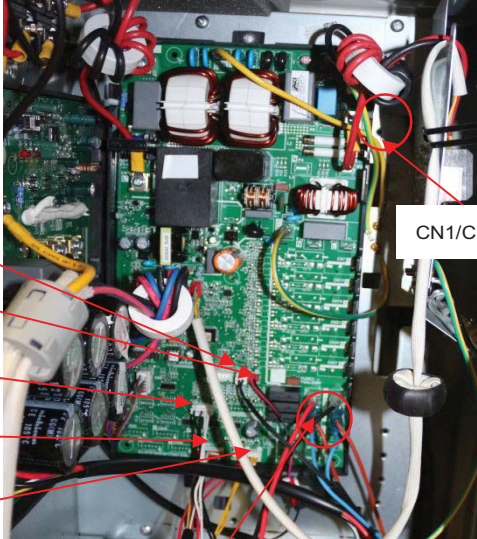
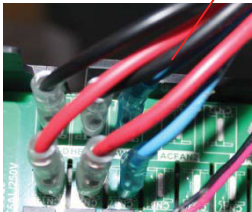
DISASSEMBLY INSTRUCTIONS SIZE 48-58 (CONT)

		<p>CN2(yellow)</p> <p>CN1(red)</p> <p>CN6(black)</p> <p>CN3(yellow)</p> <p>U、V、W(black)</p> <p>CN9(10p,white)</p> <p>4) Remove the screws securing the IPM board and remove the IBM board.</p> <p>5) Disconnect the connectors and wires connected from the PCB and other parts.</p> <p>Connectors:</p> <p>CN8: Discharge temperature sensor (2p,white)</p> <p>CN12: Heatsink temperature sensor(2p,red)</p> <p>CN9:T3/T4 temperature sensor (2p/2p,white)</p> <p>CN15: Electronic expansive valve (6p,red)</p> <p>CN10: High and low pressure switch (2p/2p, white)</p> <p>Wires:</p> <p>CN17/CN18: 4-way valve (blue-blue)</p> <p>CN19/CN20: connected to crankcase heating cable. (black-red)</p> <p>CN24/CN25: Electric heater of chassis (orange-orange)</p> <p>CN1:L-IN (red or white)</p> <p>CN3:N-IN (black)</p>	   
--	--	--	--

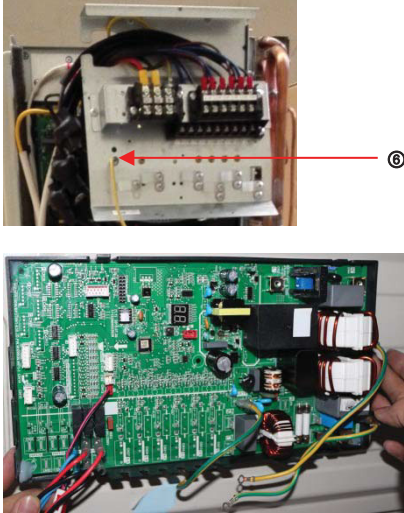
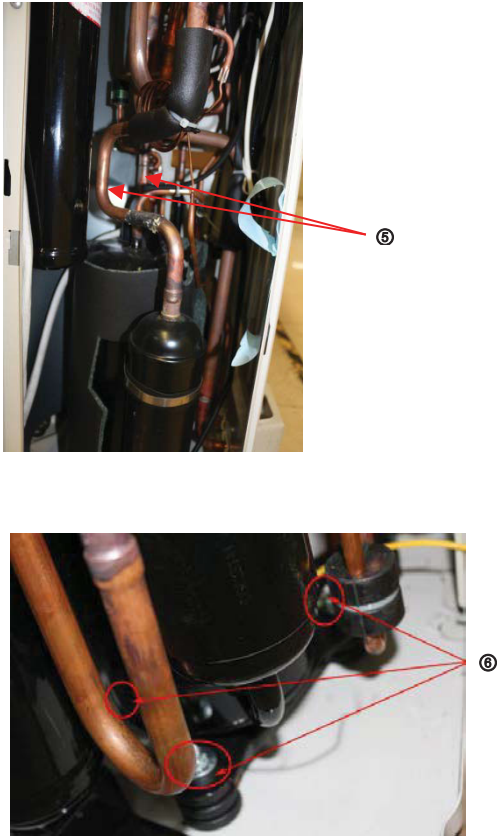
DISASSEMBLY INSTRUCTIONS SIZE 48-58 (CONT)

		<p>6) Disconnect the grounding wire (yellow-green) after removal of the big handle.</p> <p>7) Remove the PCB board.</p>	
<p>4</p>	<p>Compressor</p>	<p>Remove the compressor.</p> <p>1) Complete steps 5 - 6 in section and section 2.</p> <p>2) Extract the refrigerant gas.</p> <p>3) Remove the sound insulation material and crankcase heating cable.</p> <p>4) Remove the compressor terminal cover and disconnect the crankcase electric heater wires and compressor from the terminal.</p> <p>5) Remove the discharge pipe and suction pipe with a burner.</p> <p>6) Remove the hex nuts and washers securing the compressor to the bottom plate.</p> <p>7) Lift the compressor.</p>	

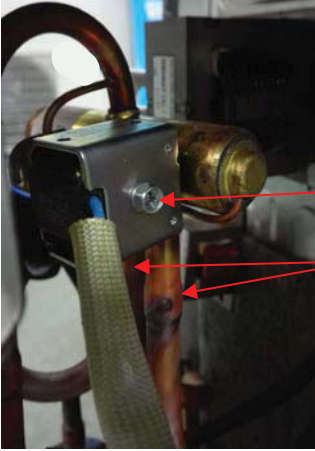
DISASSEMBLY INSTRUCTIONS SIZE 48-58 (CONT)

<p>5</p>	<p>The 4-way valve</p>	<p>Remove the 4-way valve</p> <ol style="list-style-type: none"> 1) Complete steps 5 - 6 of section 1 and section 2. 2) Extract the refrigerant gas. 3) Remove the electrical parts in section 3. 4) Remove the coil screw and remove the coil. 5) Detach the welded parts of the 4-way valve and pipe. 	 <p>Coil</p> <p>Welded parts</p>
<p>6</p>	<p>Expansion valve</p>	<p>Remove the expansion valve</p> <ol style="list-style-type: none"> 1) Complete the steps in sections 1 - 2. 2) Remove the electrical parts described in section 3. 3) Remove the coil. 4) Detach the expansion valves welded parts and pipes. 	 <p>Expansion valves</p>